

XENIA TOWNSHIP ZONING RESOLUTION



XENIA TOWNSHIP BOARD OF TRUSTEES

GREENE COUNTY, OHIO

EFFECTIVE DATE: January 1, 2020

TABLE OF CONTENTS

ARTICLE I - EXEMPTIONS	8
SECTION 101 - AGRICULTURE.....	8
SECTION 102 - PUBLIC UTILITIES AND RAILROADS	9
ARTICLE II - CONSTRUCTION OF LANGUAGE AND DEFINITIONS.....	10
SECTION 200 - CONSTRUCTION OF LANGUAGE.....	10
SECTION 201 - DEFINITIONS.....	10
27	
ARTICLE III - ZONING DISTRICTS AND MAP	34
SECTION 300 - DISTRICTS	34
SECTION 301 - DISTRICT BOUNDARIES	35
SECTION 302 - UNCERTAINTY OF BOUNDARY LOCATION	35
ARTICLE IV - DISTRICT REGULATIONS.....	36
SECTION 400 - A - AGRICULTURAL DISTRICT	36
400.1 Intent and Purpose.....	36
400.2 Permitted Principal Uses	36
400.3 Accessory Uses	36
400.4 Conditional Uses	36
400.5 Height Regulations.....	37
400.6 Yard Residence Frontage and Requirements	37
400.7 Maximum Percentage of Lot Coverage	37
SECTION 401 - E - RURAL SUBURBAN RESIDENTIAL ESTATE DISTRICT.....	38
401.2 Permitted Principal Uses	38
401.3 Accessory Uses	38
401.4 Conditional Uses	38
401.5 Yard Requirements.....	38
401.6 Building Height Requirements.....	38
401.7 Accessory Parking.....	38
401.8 Signs.....	38
401.9 Maximum Percentage of Lot Coverage	38
SECTION 402 R-1 - ONE-FAMILY RESIDENTIAL DISTRICT	39
402.1 Intent and Purpose.....	39
402.2 Permitted Principal Uses	39
402.3 Accessory Uses	39
402.4 Conditional Uses	39

402.5	Yard Requirements.....	39
402.6	Building Height Regulations.....	39
402.7	Accessory Parking.....	39
402.8	Signs.....	39
402.9	Maximum Percentage of Lot Coverage	39
SECTION 403 - RM-MULTI-FAMILY RESIDENTIAL DISTRICT		40
403.1	Intent and Purpose.....	40
403.2	Permitted Principal Uses	40
403.3	Accessory Uses	40
403.4	Conditional Uses	40
403.5	Yard Requirements.....	40
403.6	Building Height Regulations.....	40
403.7	Accessory Parking.....	40
403.8	Signs.....	40
403.9	Maximum Percentage of Lot Coverage	40
SECTION 404 - SCHEDULE OF YARD AND LOT REQUIREMENTS ZONING DISTRICTS AND DWELLINGS		41
SECTION 405 - IG - INSTITUTIONAL AND GOVERNMENTAL DISTRICT		42
405.1	Intent and Purpose.....	42
405.2	Permitted Principal Uses	42
405.3	Accessory Uses	42
405.4	Conditional Uses	42
405.5	Yard Requirements.....	42
405.6	Building Height Regulations.....	42
405.7	Maximum Percentage of Lot Coverage	42
405.8	Minimum Lot Size	42
405.9	Minimum Lot Frontage	42
SECTION 406 - B-1 - CONVENIENCE SHOPPING DISTRICT.....		43
406.1	Intent and Purpose.....	43
406.2	Permitted Principal Uses	43
406.3	Accessory Uses	43
406.4	Yard Requirements.....	43
406.5	Building Height Regulations.....	43
406.6	Accessory Parking.....	43
406.7	Off-Street Loading	43
406.8	Signs.....	43
406.10	Screening.....	43
406.11	Maximum Percentage of Lot Coverage	43

406.12 Minimum Lot Size	43
406.13 Minimum Lot Frontage	43
SECTION 407 - B-2 - NEIGHBORHOOD BUSINESS DISTRICT	44
407.1 Intent and Purpose.....	44
407.2 Permitted Principal Uses	44
407.3 Accessory Uses	45
407.4 Yard Requirements.....	45
407.5 Building Height Regulations.....	45
407.6 Accessory Parking.....	45
407.7 Off-Street Loading	45
407.8 Signs.....	46
407.9 Screening:.....	46
407.10 Maximum Percentage of Lot Coverage	46
407.11 Minimum Lot Size	46
407.12 Minimum Lot Frontage.....	46
SECTION 408 - B- 3 - HIGHWAY BUSINESS DISTRICT	47
408.1 Intent and Purpose.....	47
408.2 Permitted Principal Uses	47
408.3 Accessory Uses	48
408.4 Conditional Uses	48
408.5 Yard Requirements.....	49
408.6 Building Height Regulations.....	49
408.7 Accessory Parking.....	49
408.8 Off-Street Loading	49
408.9 Signs.....	49
408.10 Screening.....	49
408.11 Maximum Percentage of Lot Coverage	49
408.12 Minimum Lot Size	49
SECTION 409 - M-1 RESTRICTED OR LIGHT INDUSTRIAL DISTRICT:	50
409.1 Intent and Purpose.....	50
409.2 Permitted Principal Uses	50
409.3 Accessory Uses	51
409.4 Conditional Uses	51
409.5 Yard Requirements.....	51
409.6 Building Height Regulations.....	51
409.7 Accessory Parking.....	51
409.8 Off-Street Parking	51
409.9 Signs.....	51

409.10 Screening.....	51
409.11 Maximum Percentage of Lot Coverage	51
409.12 Minimum Lot Size	51
409.13 Minimum Lot Frontage	51
SECTION 410 - M-2 HEAVY INDUSTRIAL DISTRICT	52
410.1 Intent and Purpose.....	52
410.2 Permitted Principal Uses	52
410.3 Accessory Uses	53
410.4 Conditional Uses	53
410.5 Yard Requirements.....	54
410.6 Building Height Regulations.....	54
410.7 Accessory Parking.....	54
410.8 Off-Street Parking	54
410.9 Signs.....	54
410.10 Screening.....	54
410.11 Maximum Percentage of Lot Coverage	54
410.12 Minimum Lot Size	54
410.13 Minimum Lot Frontage	54
SECTION 411 M3 - MINERAL EXTRACTION AND STORAGE	55
411.1 Intent and Purpose.....	55
411.2 Application for Map Amendment	55
411.3 Mining Permits and Proposed Reclamation Bonds	58
411.4 Environmental Issues	58
411.5 Conditional Uses	60
411.6 General Provisions	62
411.7 Annual Operating Permit	63
411.8 Enforcement	63
411.9 Minimum Lot Size	63
411.10 Minimum Lot Frontage.....	63
SECTION 412 - F-1 - FLOOD PLAIN OVERLAY	64
412.1 Intent and Purpose.....	64
412.2 Prohibited Uses	64
412.3 Conditions for Permitted, Accessory Uses Within the Floodway Fringe	64
SECTION 413 – WP - WELL FIELD PROTECTION OVERLAY DISTRICT.....	66
413.1 Intent and Purpose.....	66
413.2 Permitted Uses	66
413.3 Conditional Uses	66
413.4 Prohibited Uses	67

413.5 Non-Conforming Uses	67
413.6 Groundwater Protection Standards (Quantity Limits).....	67
413.7 Management of Regulated Substances.....	69
413.8 Spills, Leaks or Discharges	70
413.9 Clean Closure Requirements.....	70
413.10 Regulated Substance Reporting	71
413.11 Enforcement	71
SECTION 414 PUD - PLANNED UNIT DEVELOPMENT	73
414.1 Intent and Purpose.....	73
414.2 Types of Planned Development Districts.....	73
414.3 Criteria for Planned Development Approval	73
414.4 Pre-Application Consultation.....	73
414.5 Developer's Options.....	73
414.6 Submission of Pre-Development Plan.....	74
414.7 Procedure for Approval of Pre-Development Plan	74
414.8 Action by the Township Trustees.....	75
414.9 Submission of Final Development Plan in Accordance with an Approved Pre- Development Plan	75
414.10 Procedure for Approval of Final Development Plan with Approved Pre- Development Plan	76
414.11 Submission of Final Development Plan Without an Approved Development Plan	77
414.12 Action by the Township Zoning Commission on Single State Development Plan.	77
414.13 Action by the Board of Township Trustees	78
414.14 Extension of Time or Modification.....	78
414.15 "PD-R" Planned Residential District.....	78
414.16 "PD-B" Planned Business District	80
414.17 "PD-M" Planned Industrial District	80
SECTION 415 R-MH MOBILE HOME PARK/COMMUNITY DISTRICT	82
415.1 Intent and Purpose.....	82
415.2 Permitted Principal Uses	82
415.3 Accessory Uses	82
415.4 Yard Requirements.....	82
415.6 Signs.....	82
ARTICLE V - GENERAL PROVISIONS	83
SECTION 500 GENERAL REGULATIONS	83
SECTION 501 YARD REQUIRED FOR CORNER AND THROUGH LOTS.....	83
SECTION 502 CORNER LOT ACCESSORY BUILDING	83
SECTION 503 LOTS ADJOINING ALLEYS	83
SECTION 504 ACCESSORY BUILDING	83

SECTION 505 HEIGHT OF FENCES	84
SECTION 506 ESSENTIAL SERVICES	84
SECTION 507 EXTERNAL EFFECTS	84
SECTION 508 OUTDOOR STORAGE AND WASTE DISPOSAL.....	85
SECTION 509 PROJECTIONS INTO REQUIRED YARDS.....	85
SECTION 510 EXCEPTIONS TO HEIGHT LIMITATIONS.....	85
SECTION 511 TEMPORARY USES.....	85
SECTION 512 MAJOR STREET SETBACKS	86
SECTION 513 OFF-STREET LOADING REGULATIONS.....	86
513.1 General Provisions	86
513.2 Amount of Loading Space Required.....	86
SECTION 514 OFF-STREET PARKING REGULATIONS	87
514.1 General Provisions	87
514.2 Amount of Off-Street Parking Spaces Required.....	88
SECTION 515 SCREENING.....	90
515.1 Purpose of Screening.....	90
515.2 Type of Screening	Error! Bookmark not defined.
SECTION 516 DELETED	90
SECTION 517 PERMITTED SIGNS	90
517.1 Scope of Regulations.....	90
517.2 Exemptions.....	91
517.3 Subdivision Signs (Page 85)	91
517.4 Allowable Signage by District (Page 85).....	91
SECTION 518 TOWERS.....	93
SECTION 519 NON-CONFORMITIES.....	94
519.1 Non-Conforming Lots of Record	94
519.2 Non-conforming Uses of Land.....	94
519.3 Non-Conforming Structures.....	95
519.4 Non-Conforming Uses of Structures.....	95
519.5 Repairs and Maintenance	95
519.6 Restoring Buildings.....	95
519.7 Violations not Rendered Non-Conforming.....	95
SECTION 520 TRAILERS	96
520.1 Temporary Residence.....	96
520.2 Camping and Sport Vehicles.....	96
SECTION 521 DRIVE-IN SERVICE ESTABLISHMENT.....	96
SECTION 522 BARRIERS TO ENCROACHMENT	96
SECTION 523 ENFORCEMENT AND PENALTIES.....	96

523.1	Enforcing Officer	96
523.2	Zoning Permit.....	96
523.3	Certificate of Health Officer	96
523.4	Certificate of Zoning Compliance.....	97
523.5	Remedies	97
523.6	Other Action.....	97
523.7	Penalties	97
523.8	Affected Parties	97
523.9	Driveways	97
523.10	Driveway Standard Regulations.....	97
SECTION 524 PRIVATE POOLS.....		98
SECTION 525 VEGETATION CONTROL.....		98
SECTION 526 HOME OCCUPATIONS		99
SECTION 527 ADULT BUSINESSES		99
ARTICLE VI – BOARD OF APPEALS.....		101
SECTION 600 BOARD OF APPEALS.....		101
600.1	Creation.....	101
600.2	Membership and Appointment.....	101
600.3	Organization.....	101
600.4	Official Action	101
600.5	Right of Petition or Appeal	101
600.6	Fee.....	101
ARTICLE VII - AMENDMENTS		105
SECTION 700 AMENDMENTS.....		105
700.1	Right of Amendment.....	105
700.2	Recommendation of Township Zoning Commission.....	105
700.3	Amendment Limitations.....	105
700.4	Continuation of Public Hearings	105
700.5	Fee.....	105
700.6	Validity and Severity.....	105
700.7	Interpretation and Conflict	105
700.8	Repeal of Conflicting Resolution.....	106

ARTICLE I - EXEMPTIONS

SECTION 101 - AGRICULTURE

1. Except as otherwise provided in division (B) of this section, sections 519.02 to 519.25 of the Ohio Revised Code confer no power on any township zoning commission, board of township trustees, or board of zoning appeals to prohibit the use of any land for agricultural purposes or the construction or use of buildings or structures incident to the use for agricultural purposes of the land on which such buildings or structures are located, including buildings or structures that are used primarily for venting and selling wine and that are located on land any part of which is used for viticulture, and no zoning certificate shall be required for any such building or structure.
2. A township zoning resolution, or an amendment to such resolution may in any platted subdivision approved under section 711.05, 711.09, or 711.10 of the Ohio Revised code, or in any area consisting of fifteen or more lots approved under section 711.131 of the Ohio Revised Code that are contiguous to one another, or some of which are contiguous to one another and adjacent to one side of a dedicated public road, and the balance of which are contiguous to one another and adjacent to the opposite side of the same dedicated public road regulate:
 - a. Agriculture on lots of one acre or less;
 - b. Buildings or structures incident to the use of land for agricultural purposes on lots greater than one acre but not greater than five acres by: set back building lines; height; and size;
 - c. Dairying and animal and poultry husbandry on lots greater than one acre but not greater than five acres when at least thirty-five percent of the lots in the subdivision are developed with at least one building, structure, or improvement that is subject to real property taxation or that is subject to the tax on manufactured and mobile homes under section 4503.06 of the Ohio Revised Code. After thirty-five percent of the lots are so developed, dairying and animal and poultry husbandry shall be considered non-conforming use of land and buildings or structures pursuant to section 519.19 of the Ohio Revised Code.

Division (2) of this section confers no power on any township zoning commission, board of township trustees, or board of zoning appeals to regulate agriculture, buildings, or structures, and dairying and animal and poultry husbandry on lots greater than five acres.

3. Such sections confer no power on any township zoning commission, board of township trustees, or board of zoning appeals to prohibit in a district zoned for agricultural, industrial, residential, or commercial uses, the use of any land for:
 - a. A farm market where fifty percent or more of the gross income received from the market is derived from produce raised on farms owned or operated by the market operator in a normal crop year. However, a board of township trustees, as provided in section 519.02 of the Ohio Revised Code, may regulate such factors pertaining to farm markets as size of the structure, size of parking areas that may be required, set back building lines, and egress or ingress, where such regulation is necessary to protect the public health and safety.
 - b. Biodiesel production, biomass energy production, or electric or heat energy production if the land on which the production facility is located qualifies as land devoted exclusively to agricultural use under sections 5713.30 to 5713.37 of the

Ohio Revised Code for real property tax purposes. As used in division (3)(B) of this section, “biodiesel”, “biomass energy”, and “electric heat energy” have the same meanings as in section 5713.30 of the Ohio Revised Code.

- c. Biologically derived methane gas production if the land on which the production facility is located qualifies as land devoted exclusively to agricultural use under sections 5713.30 to 5713.37 of the Ohio Revised Code for real property tax purposes and if the facility that produces the biologically derived methane gas does not produce more than seventeen million sixty thousand seven hundred ten British thermal units, five megawatts, or both.

As used in division (3)(c) of this section, “biologically derived methane gas” has the same meaning as in section 5413.30 of the Ohio Revised Code.

SECTION 102 - PUBLIC UTILITIES AND RAILROADS

Section 519.211 of the Ohio Revised Code confers no power on any Board of Township Trustees or Board of Zoning Appeals in respect to the location, erection, construction, reconstruction, change, alteration, maintenance, removal, use or enlargement of any buildings or structure of any public utility or railroad, whether publicly owned, or the use of land by any utility or railroad, for the operation of its business.

Such sections do confer such power on any Board of Township Trustees or Board of Zoning Appeals with respect to any tower that is owned or used by a public utility, used in the provision of cellular telephone communication services and proposed to be located in an area zoned for residential use.

ARTICLE II - CONSTRUCTION OF LANGUAGE AND DEFINITIONS

SECTION 200 - CONSTRUCTION OF LANGUAGE

For the purposes of this Resolution, certain terms or words used herein shall be interpreted as follows:

The word "person" includes a firm, association, organization, partnership, trust, company or corporation as well as an individual; the present tense includes the future tense, the singular number includes the plural, and the plural number includes the singular; the word "shall" is mandatory, and the word "may" is permissive; the words "used" or "occupied" include the words "intended", "designated", or "arranged to be used or occupied"; the word "building" includes the word "structure", and the word "dwelling" includes the word "residence"; the word "lot" includes the words "plot" or "parcel". In cases of any difference of meaning or implication between the text of this Resolution and any caption or illustration, the text shall control.

Terms not herein defined shall have the meaning customarily assigned to them.

SECTION 201 - DEFINITIONS

Accessory Use or Building:

A use or building on the same lot with, and of a nature customarily incident and subordinate to, those of the main use or building, as determined by the Zoning Inspector.

Active Mining:

The footprint has been disturbed by mining and more than two hundred and fifty (250) tons of mineral have been produced for a period of twelve (12) months as reported in the annual report submitted by the applicant to state agencies with oversight responsibilities for mineral extraction operations.

Adult Arcade:

Adult Arcade shall mean an establishment where one or more still or motion picture projectors, slide projectors or similar machines, or other image-producing machines, for viewing by five or fewer persons each, are regularly used to show films, motion pictures, video cassettes, DVDs, internet streaming video, slides or other photographic reproductions which are characterized by the depiction or description of specified sexual activities or specified anatomical areas.

Adult Cabaret:

Adult Cabaret shall mean a nightclub, bar, restaurant, "bottle club" or similar commercial establishment, whether or not alcoholic beverages are served, whether private or public, which regularly features any one of the following: Persons who appear nude or in a state of nudity or semi-nudity; live performances which are characterized by the exposure of specified anatomical areas or by specified sexual activities; or films, motion pictures, videocassettes, slides, or other photographic reproductions that are characterized by the depiction or description of specified sexual activities or specified anatomical areas.

Adult Novelty Store:

Adult Novelty Store means an establishment having at least twenty-five percent (25%) of: its retail floor space used for the display of adult products; or stock in trade consisting of adult products; or weekly revenue derived from adult products, for any form of

consideration, or any one or more of the following: Instruments, devices, or paraphernalia which are designed for use or marketed primarily for stimulation of human genital organs or for sadomasochistic use or abuse of the user or others.

Adult Theater:

Adult Theater includes:

1. Adult Drive-in Theater shall mean an outdoor theater for presenting material distinguished or characterized by an emphasis on matter depicting, describing or relating to specified sexual activities or specified anatomical areas for observation by patrons, which may not be located on a parcel of property less than five (5) acres.
2. Adult Motion Picture Theater shall mean an enclosed building of one or more persons used for presenting material distinguished or characterized by an emphasis on matter depicting, describing or relating to specified sexual activities or specified anatomical areas for observation by patrons.

Adult Video or Book Store:

Adult Video or Book Store shall mean an establishment having as a substantial or significant portion of its stock in trade, books, magazines and other periodicals which are distinguished or characterized by their emphasis on matter depicting, describing or relating to specified sexual activities or specified anatomical areas, or an establishment with a segment or section devoted to the sale or display of such material.

Agribusiness:

Manufacturing, warehousing, storage, and related industrial and commercial activities that provide services for or are dependent upon agricultural activities found within the Agricultural District, and are not necessarily suited to locations within an established community. Agri-business includes, but is not limited to the following uses: fertilizer production, sales, storage and blending; sales and servicing of farm implements and related equipment; preparations and sale of feeds for animals and fowl; seed sales; poultry hatchery services; corn shelling, hay baling, and threshing services; grain elevators and bulk storage of feed grains; horticultural services; agricultural produce, milling and processing; livestock auctions and retail nurseries.

Agriculture:

The use of a tract of land for farming; ranching; alga culture meaning the farming of algae; aquaculture; apiculture; horticulture; viticulture; animal husbandry, including, but not limited to, the care and raising of livestock, equine, and fur-bearing animals; poultry husbandry and the production of poultry and poultry products; dairy production; the production of field crops, tobacco, fruits, vegetables, nursery stock, ornamental shrubs, ornamental trees, flowers, sod, or mushrooms; timber; pasturage; any combination of the foregoing; and the processing, drying, storage, and marketing of agricultural products when those activities are conducted in conjunction with, but are secondary to, such husbandry or production, however, that:

1. The operation of any such accessory use defined above shall be secondary to that of normal agricultural activities;
2. The above uses shall not include the commercial feeding of garbage or offal to swine or other animals;
3. The above uses shall not include the operation or maintenance of a commercial feed lot or a commercial stockyard.

Agritourism

Has the same meaning as in section 910.80 of the Ohio Revised Code. As of 8/16/2016, ORC 901.80(A)(2) reads as follows: "Agritourism" means an agriculturally related educational, entertainment, historical, cultural, or recreational activity, including you-pick operations or farm markets, conducted on a farm that allows or invites members of the general public to observe, participate in. or enjoy that activity.

Airport, Private:

Any runway, landing strip or other facility designed or used by any person for the landing, take-off, and storage of aircraft on his own property principally for his own use.

Alley:

Any dedicated public way affording a secondary means of access to abutting property, and not intended for general traffic circulation.

Alteration:

Any change, addition, or modification in construction or type of occupancy; any change in the structural members of a building, such as walls or partitions, columns, beams or girders the consummated act of which may be referred to herein as "altered" or "reconstructed".

Antenna. Any panel, whip, dish or other apparatus designed for communications through the sending and/or receiving of electromagnetic waves, excluding any support structure other than brackets/platforms.

Antenna Support Structure. Any building or other structure other than a tower which is used for location of an antenna.

Apartment:

A suite of rooms or a room in a multi-family building arranged and intended for a place of residence of a single family or a group of individuals living together as a single housekeeping unit as herein defined.

Apartment Hotel:

A building designed for or containing both dwelling units and individual guest rooms or suites or rooms, which building may include accessory uses such as cigar store, coffee shop, etc., when such uses are accessible only from the lobby.

Architectural Feature. Esthetic or practical elements of the structure not intended for the shelter or the enclosure of persons, animals, or chattels.

Auto Sales or Rental:

A building lot, or both used for the display, sale, or rental of new or used motor vehicles in operable condition and where repair service is incidental.

Auto Service Station:

A place where gasoline, or any other automobile engine fuel (stored only with EPA approved method), kerosene, or motor oil and lubricants or grease (for operation of motor vehicles) are retailed directly to the public on the premises; including the sale of minor accessories and the servicing of and minor repair of automobiles, not including storage of inoperable vehicles.

Auto Repair Station:

A place where, along with the sale of engine fuels, the following services may be carried out: general repair, engine rebuilding, rebuilding or reconditioning of motor vehicles; collision service, such as body, frame, or fender straightening and repair, overall painting and undercoating of automobiles.

Barn:

An accessory structure upon a lot customarily used for the housing of livestock and for the storage of crops and/or machinery used in bona fide agricultural activities as previously defined in this Section.

Basement:

That portion of a building which is partly or wholly below grade but so located that the vertical distance from the average grade to the floor is greater than the vertical distance from the average grade to the ceiling. A basement shall not be counted as a story, except as provided in the definition for Story.

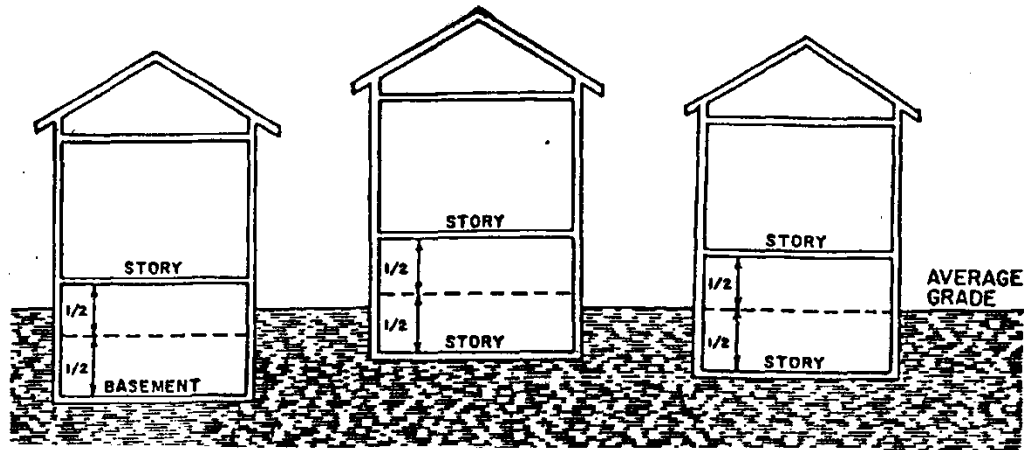

Bed and Breakfast:

Accommodations in a private home which offers a room and breakfast for one inclusive price for an overnight stay to travelers.

Best Available Technology:

Any combination of work practices, source design characteristics, and air pollution control devices that have been previously demonstrated to operate satisfactorily on substantially similar applications. Best available technology shall be used to prevent the creation of detrimental ground vibrations, sound, pressure, smoke, noise, odors, or dust which would injure or be a nuisance, or which may adversely affect the health, safety, morals and general welfare of any persons living or-working in the vicinity. All in-plant haul roads and stockpiles shall be sprinkled with water and or/chemicals as necessary to control dust emissions.

Block:

The property abutting one side of a street and lying between the two nearest intersecting streets (crossing or terminating) or between the nearest such street and railroad right-of-way, un-subdivided acreage, river or live stream; or between any of the foregoing and any other barrier to the continuity of development, or corporate lines of the municipality.

Board of Appeals:

Means the Board of Zoning Appeals of Xenia Township, Greene County, Ohio.

Boarding House (Rooming House):

A building other than a hotel, where for compensation and by pre-arrangement for definite periods, meals or lodging and meals are provided for three or more persons, but not exceeding ten sleeping rooms. A rooming house or a furnished room house shall be deemed a boarding house for the purposes of this Resolution.

Buffer Area:

That portion of a lot set aside for open space and visual screening purposes pursuant to applicable provisions of this Resolution, to separate or screen different use districts and/or uses on one property from uses on another property.

Building:

Any structure, either temporary or permanent, having a roof supported by columns or walls, and intended for the shelter or the enclosure of persons, animals, chattels, or property of any kind.

Building Height:

The vertical distance measured from the established grade to the highest point of the roof surface for flat roofs, to the deck line of mansard roofs, and to the average height between eaves and ridge for gable, hip and gambrel roofs. Where a building is located on sloping terrain, the height may be measured from the average ground level of the grade at the building wall.

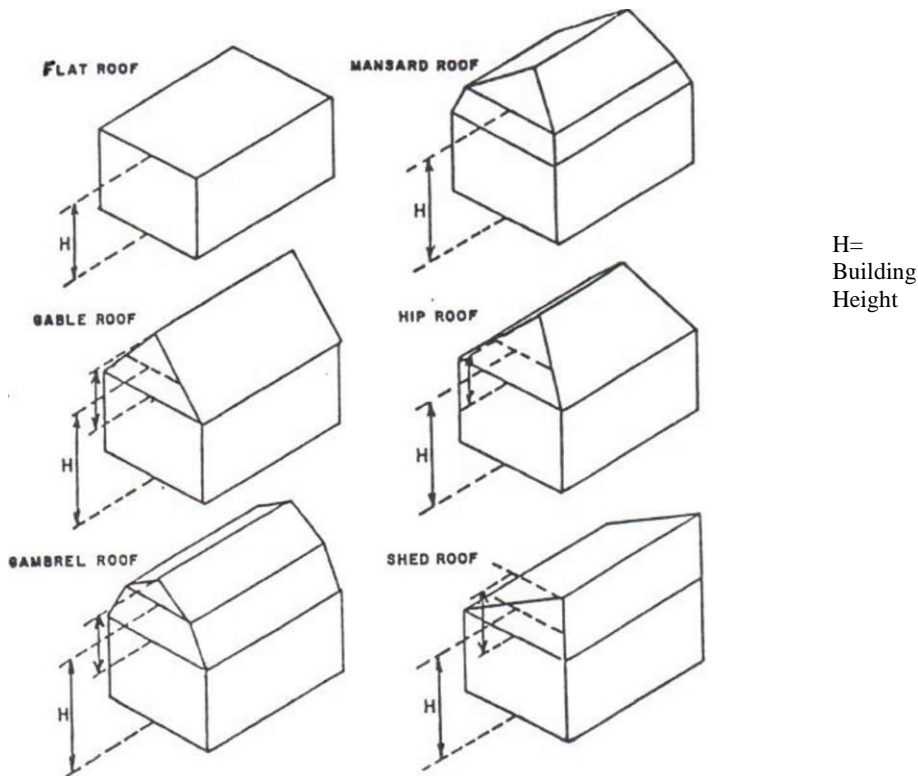

Building Line:

A line formed by the face of the building, and for the purpose of this Resolution, a building line is the same as a front setback line.

Carry-Out:

A place of business where food and beverages are purchased for consumption off the premises.

Cemetery:

Land used, or intended to be used, for the burial of animal or human dead and dedicated for cemetery purposes, including crematories, mausoleums, and mortuaries, if operated in connection with and within the boundaries of such cemetery.

Clinic:

An establishment where human patients who are not lodged overnight are admitted for examination and treatment by a group of physicians, dentists or similar professions.

Club:

An organization of persons for special purposes or for the promulgation of sports, arts, sciences, literature, politics, or the like, but not operated for profit.

Commercial Recreational Facilities, Indoor:

Any commercial activity conducted primarily indoors which is related to the recreation field, such as bowling alleys, skating rinks, indoor tennis courts, indoor motion picture theaters and similar recreational activities.

Commercial Recreational Facilities, Outdoor:

Any commercial activity conducted primarily outside a building which is related to the recreation field, such as drive-in theaters, community swimming pools, miniature golf, driving ranges, skiing facilities, country clubs, and similar activities.

Common Areas:

As used herein, parcels of land, together with the improvements thereon, the use and enjoyment of which shall be shared by the owners and occupants of the individual building sites within a development.

Community Center:

A building or group of buildings for social, cultural, recreational or educational activities, associated with a neighborhood or the entire community.

Community Water Supply System

A water system which has at least 15 service connections used by year round residents of the area or regularly serves 25 year round residents, as defined by the Ohio EPA.

Conditional Use:

A conditional use is a use permitted only after approval of an application by the Township Board of Zoning Appeals such review being necessary because the provisions of this Resolution governing conditions, precedent or subsequent, are not precise enough to all applications. A conditional use does not require "undue hardship" in order to be allowable. The conditional uses that are found in this Resolution appear as "special approval" by the Xenia Township Board of Zoning Appeals.

Conditional Use Permit:

A permit granted by the Board of Zoning Appeals to allow certain specific uses that would not otherwise be allowed in that particular zoning district where the land is located. These permits are issued only after the applicant has followed the procedures as stated in this Resolution. Conditional use differs from a zoning change in that it is much more specific. The applicant submits plans and, if approved, he must follow those plans exactly or reapply for a permit before deviating from that plan. Conditional Use is held by the property owner and is void when the property ownership changes or the conditional use ceases for a period of two years.

Condominiums:

An apartment building in which the apartments are owned individually.

Cul-de-sac:

A dead-end street, which will include a turnaround space. This definition will clarify road frontage in pie-shape lots.

Density:

A unit of measurement designating the number of dwelling units per acre of land as follows:

1. Gross Density: The number of dwelling units per acre of the total land to be developed.
2. Net Density: The number of dwelling units per acre of land when the acreage involved includes only the land devoted to residential uses and excludes such areas as street right-of-way, and other similar uses.

District:

A portion of the un-incorporated area of the Township within which certain regulations and requirements or various combinations thereof apply under the provision of this Resolution.

Drive-In:

A business establishment so developed that its retail or service character is dependent on providing a driveway approach or parking spaces for motor vehicles so as to serve patrons while in the motor vehicle, or within a building or structure on the same premises and devoted to the same purpose as the drive-in service.

Drive-In Theater:

A form of cinema structure consisting of an outdoor screen, projector booth, concession stands and a parking area.

Dwelling:

One or more rooms designed for or used as a unit to provide complete housekeeping facilities for one individual family with sleeping facilities, permanently installed cooking facilities, and lawfully required sanitary facilities. This definition shall include "modular homes" as defined in this Resolution.

Dwelling, One-family:

A building designed exclusively for and occupied exclusively by one (1) family.

Dwelling, Two-family:

A building designed exclusively for occupancy by two (2) families living independently of each other.

Dwelling, Multi-family:

A building or a portion thereof, designed exclusively for occupancy by three (3) or more families living independently of each other.

Erected:

Any built, constructed, altered, reconstructed, moved upon, or any physical operations on the premises which are required for the construction. Excavation, fill, drainage, and the like, shall be considered a part of erection.

Essential Services:

The erection, construction, alteration or maintenance by public utilities or governmental departments of underground, surface, or overhead gas, electrical, telephone, telegraph, steam, fuel or water transmission or distribution systems, including towers, poles, wires, mains, drains, sewers, pipes, conduits, cables, fire alarm and police call boxes, traffic signals, hydrants and similar accessories in connection therewith, but not including buildings which are necessary for the furnishing of adequate service by such utilities or governmental departments for the general health, safety or welfare.

Excavation:

Any breaking of ground, except common household gardening and ground care.

Family:

One or two persons or parents, with their direct lineal descendants and adopted children together with not more than two persons not so related, or a group of not more than three persons who need not be related, living together as a single housekeeping unit in a dwelling unit.

Farm:

All of the contiguous neighboring or associated land operated as a single unit on which bona fide farming is carried on directly by the owner-operator, manager or tenant farm, by his own labor or with the assistance of members of his household or hired employees. The use of land for purposes including farming, dairying, pasturage, apiculture, horticulture, floriculture, viticulture, animal and poultry husbandry, and the necessary accessory uses for packing, treating or storing the produce. The operation of any such accessory uses shall be secondary to that of normal agricultural activities. The above uses shall not include the commercial feeding of garbage or offal to swine or other animals.

Feed Lot:

Land used for the confining and commercial feeding of livestock for mass production and marketing, and not necessarily connected with any general farming upon the same lot. All feed lots shall obtain appropriate permits for waste treatment and disposal from the Ohio Environmental Protection Agency prior to the issuance of a zoning permit.

Fence:

Any structure, other than part of a building, which encloses, partially encloses or divides any area.

Fill:

Soil, rock, earth, sand, gravel, or any other material exceeding a total of one hundred (100) cubic yards or more than four (4) feet in vertical height at its deepest point which may be deposited or placed onto or into the ground.

Filling:

The depositing or dumping of any matter onto, or into the ground, except common household gardening and ground care.

Flood, Base:

The temporary inundation of normally dry land areas by a flood covering the special flood hazard area, also referred to as the one-hundred (100) year flood or the 1% chance annual flood. The area is determined by the Flood Insurance Study (FIS), unincorporated Areas of Greene County, Ohio and by the Flood Insurance Rate Map (FIRM), unincorporated Areas of Greene County, Ohio. The FIS and FIRM area is determined by an official report and map on which the Federal Emergency Management Agency (FEMA) or the U.S. Department of Housing and Urban Development (HUD) has delineated the areas of special flood hazards.

Limit as Determined by FIS/FIRM

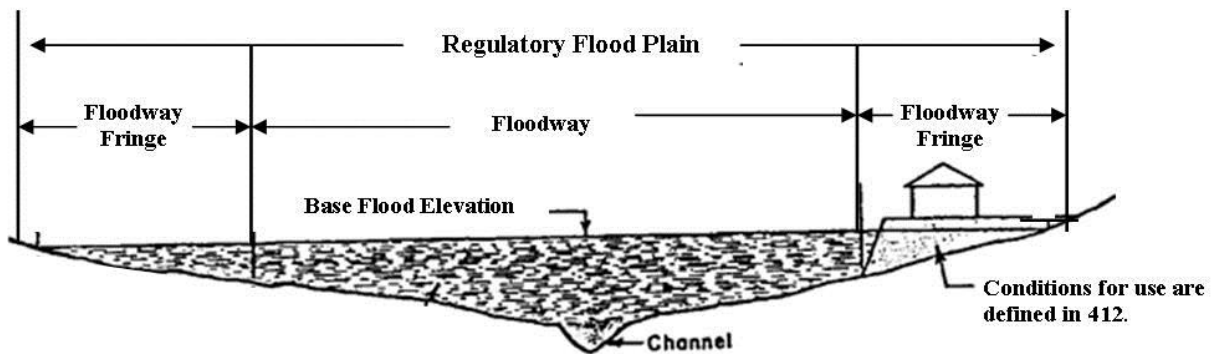

Flood Plain, Regulatory:

That land area of Xenia Township which is subject to inundation by the base flood. (See Flood, Base Illustration)

Floodway:

That portion of the regulatory flood plain which is required to carry and discharge the flood waters of the base flood without obstruction. (See Flood, Base Illustration)

Floodway Fringe:

That portion of the regulatory flood plain which serves primarily as a storage area for the flood waters of the base flood. (See Flood, Base Illustration)

Floor Area:

For the purpose of computing the minimum allowable floor area in a residential dwelling unit, the sum of the horizontal areas of each story of the building shall be measured from the exterior faces of the exterior walls. The floor area measurement is exclusive of areas of basements, unfinished attics, attached garages, breezeways and enclosed and un-enclosed porches, except basement areas designed and used for dwelling or business purposes.

Floor Area Gross:

The sum of the gross horizontal areas of all the several floors of a building or buildings, including interior balconies and mezzanines. All horizontal measurements are to be made between the exterior faces of walls including: the walls of roofed porches having more than one wall. The gross floor area of a building shall include the floor area of accessory buildings, on the same lot, measured the same way.

Floor Area (for the purpose of computing parking):

That area used for or intended to be used for the sale of merchandise or services, or for use to serve patrons, clients or customers. Such floor area which is used or intended to be used principally for the storage or processing of merchandise, such as hallways, stairways, and elevator shafts, or for utilities or sanitary facilities, shall be excluded from this computation of "Floor Area". Measurements of usable floor area shall be the sum of the horizontal areas of the several floors of the building, measured from the exterior faces of the exterior walls.

Frontage:

1. The distance between the side lot lines measured along the required front setback line;
- and 2. In the case of a corner lot where frontage will be measured along the shortest front

lot line. Property lines which abut limited access roads shall not be construed to be included within any calculation of frontage.

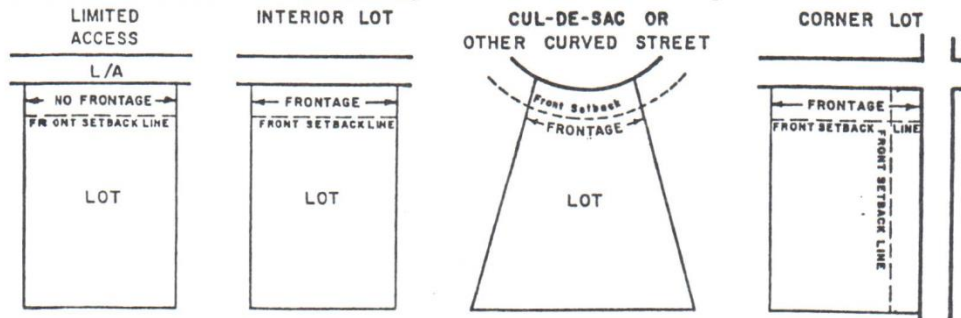

Garage; Parking:

A space or structure or series of structures for the temporary storage or parking of operable motor vehicles, not primarily of commercial vehicles, having no public shop or service in connection therewith, other than for the supplying of motor fuels and lubricants, air, water and other operating commodities wholly within the buildings, to the patrons of the garage only and not readily visible from or advertised for sale on the exterior of the building.

Garage; Private:

An accessory building or portion of a main building designed or used solely for the storage of motor-driven vehicles, boats, and similar vehicles owned or used by the occupants of the building to which it is accessory.

Garage, Public:

A space or structure for the storage, sale, hire, care, repair or refinishing of self-propelled vehicles.

Grade (Ground Level):

The average of the finished ground level at the center of all walls of a building. In case walls are parallel to and within five (5) feet of a sidewalk, the above ground level shall be measured at the sidewalk, unless otherwise defined herein.

Hedge:

A line of densely growing shrubs or bushes which encloses, partially encloses or divides any area.

Home Occupation:

Home occupation refers to an occupation operated in its entirety within a building by a person or persons maintaining a residence on the property. Home occupation shall not utilize more than five hundred (500) square feet and not display or create outside the structure any external evidence of the operation of the home occupation, except for one (1) un-animated, non-illuminated, nameplate having an area of not more than one (1) square foot attached to the building entrance. This use is a Conditional Use in an Agriculture District.

Hospital:

A public or semi-public facility that provides accommodations and continuous service for the sick and injured including obstetrical, medical and surgical care.

Hotel:

A building occupied as the more-or-less temporary abiding place of individuals who are lodged with or without meals in which there are ten (10) or more sleeping rooms and no

provision made for cooking in any individual room or apartment. A hotel may include a restaurant or cocktail lounge, public banquet halls, ballrooms, or meeting rooms.

Institutional and Governmental:

Areas developed or reserved for educational institutions, hospitals and other institutions of a religious, charitable or philanthropic or governmental agency nature.

Junk or Inoperable Vehicle:

As defined by Ohio Revised Code, §505.173, a junk motor vehicle means a motor vehicle that meets all of the following criteria:

1. Three model years old, or older;
2. Apparently inoperable;
3. Extensively damaged, including, but not limited to, any of the following: missing wheels, tires, engine, or transmission.

Junk Yards (Salvage Yards):

An open area where waste, used or second-hand materials are bought and sold, exchanged, stored, baled, packaged, disassembled, or handled including but not limited to scrap iron and other metals, paper, rags, rubber tires, and bottles. A "Junk Yard" includes automobile wrecking yards and includes any area of more than two hundred (200) square feet for storage, keeping or abandonment of junk, but does not include uses established within enclosed buildings.

Landscaped:

Sodded, seeded and/or shrubbed.

Loading Space:

An off-street space on the same lot with a building, or group of buildings, for the temporary parking of a commercial vehicle while loading and unloading merchandise or materials.

Lot:

A parcel of land occupied, or to be occupied, by a main building or group of such buildings and accessory buildings, or utilized for the principal use and uses accessory thereto, together with such open spaces as are required under the provisions of this Resolution. Every lot shall abut upon and have permanent access to a dedicated public street or approved private street.

Lot Area:

The total horizontal area within the lot lines of the lot.

Lot, Corner:

A lot which has at least two contiguous sides, each abutting upon a street for its full length. (See Illustration)

Lot, Interior:

Any lot other than a corner lot. (See Illustration)

Lot, Through (Double Frontage):

Any interior lot having frontage on two, more or less, parallel streets as distinguished from a corner lot. In the case of a row of double-frontage lots, all sides of said lots adjacent to streets shall be considered frontage, and front yards shall be provided as required. (See Illustration)

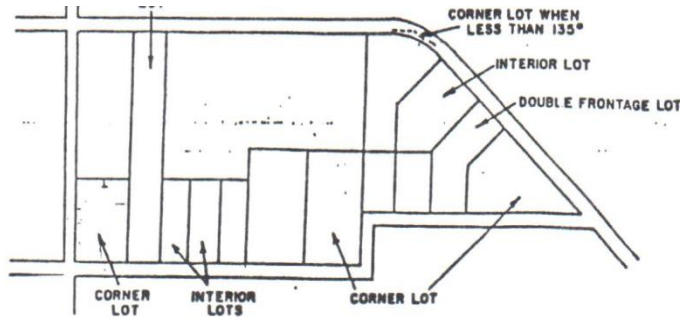

Lot Coverage:

The part or percent of the lot occupied by buildings including accessory buildings. (See Illustration)

Lot Lines:

The lines bounding a lot as defined in Article II Definitions (Front Lot Lines, Rear Lot Line, Lot Width) (See Illustration)

Lot Line, Front:

In the case of an interior lot, that line separating said lot from the street. In the case of a corner lot, or double frontage lot, that line separating said lot from either street. (See Illustration)

Lot Line, Rear:

That lot line opposite the front lot line. In the case of a lot pointed at the rear, the rear lot line shall be an imaginary line parallel to the front lot line, not less than ten (10) feet long lying farthest from the front lot line and wholly within the lot. In the case of a corner lot, the rear lot line is opposite the front lot line of least dimension. (See Illustration)

Lot Width:

The horizontal distance between the side lot lines, measured at the two points where the building line or setback line intersects the side lot line. Not to be construed as lot frontage. (See Illustration)

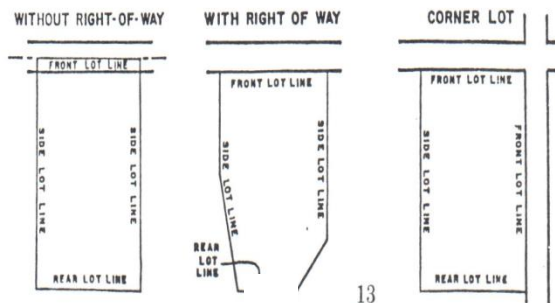

13

Lot of Record:

A parcel of land, the dimensions of which are shown on a document or map on file with the County Register of Deeds or in common use by County Officials, and which actually exists as so shown, or any part of such parcel held in a record ownership separate from that of the remainder thereof.

Main Building:

A building in which is conducted the principal use of the lot upon which it is situated.

Main Use:

The principal use to which the premises are devoted and the principal purpose for which the premises exists.

Major Thoroughfare:

An arterial street which is intended to serve as a large volume traffic-way for both the immediate area and the region beyond, and may be designated as a major thoroughfare, parkway, freeway, expressway, or equivalent term to identify those streets comprising the basic structure of the street plan.

Major Thoroughfare Plan:

The official plan, as adopted by the Planning Commission, of the major highways and streets, on file in the office of the County Recorder, including all amendments and supplements subsequently adopted.

Manufacturing, Heavy:

Fabrication, altering, converting, assembling, storing, testing, and similar industrial uses which are generally major operations, extensive in character and requiring large sites, large open storage and service areas, extensive accessory facilities, and ready access to regional transportation. Heavy manufacturing uses may normally generate some nuisances such as smoke, noise, vibration, dust, glare, air pollution, industrial traffic and water pollution.

Manufacturing, Light:

Manufacturing or other industrial uses which are usually controlled operations and normally do not require large sites. Such uses are normally relatively clean, quiet, and free of objectionable or hazardous elements such as smoke, noise, vibration, odor, water pollution, glare, air pollution, and dust. Light manufacturing uses normally operate and store material within enclosed structures, and generate little industrial traffic or nuisance.

Master Plan:

The comprehensive plan approved by the Xenia Township Zoning Commission including graphic and written proposals indicating the general location for streets, parks, schools, public buildings and all physical development of the Township and includes any unit or part of such plan, and any amendment to such plan or parts thereof.

Mezzanine:

An intermediate floor in any story occupying not to exceed two-thirds (2/3) of the floor area of such story.

Mineral Extraction Operation:

Any operation, including accessory buildings, roads, or structures, involving the excavation, mining, quarrying, storage, separation, cleaning and/or processing of clay, sand, gravel, limestone, shale, or other mineral resource. Such operation shall include all of the land or property that is used or owned in reserve by the person, firm, or corporation involved in such operation. Mineral extraction is an interim land use and such operations shall possess a plan for ultimate use of the property.

Mobile Home:

A manufactured re-locatable residential unit providing complete, independent living facilities for one family including permanent provisions for living, sleeping, eating, cooking, and sanitation and the design and construction of which meets the standards and specifications of the United State Department of Housing and Urban Development. A mobile home is not included within the definition of "Modular Home" and the removal of running gear shall not exempt a mobile home from this definition.

Mobile Home Park/Community District:

Any lot upon which two or more mobile homes are located for residential use, either free of charge or for revenue purposes. A mobile home park shall include any roadway, building, structure, vehicle, or enclosure used or intended for use as a part of the facilities of such park.

Modular Home:

A factory-fabricated transportable building consisting of two or more units designed to be assembled into a permanent structure at a building site on a permanent foundation and used for residential purposes by one family, and is built to meet the standards and specifications of the Industrial Unit Standards of the Ohio Building Code. Must be manufactured after 1995 and must have the HUD seal of approval. Must also meet single family residential requirements.

Motel:

A series of attached, semi-detached or detached rental units containing a bedroom, bathroom and closet space. Units shall provide for overnight lodging and are offered to the public for compensation, and shall cater primarily to the public traveling by motor vehicle. It may include all facilities specified under the definition of Hotel.

Noise

Any sound which is unwanted or which causes or tends to cause an adverse psychological or physiological effect on human beings.

Noise Control Device:

Any method, process or equipment which reduces the generation or radiation of noise or which renders the noise less noxious.

Noise Permit:

A permit authorized to be issued by the Township.

Noise Pollution:

Noise in excess of the limits as stated in this chapter.

Non-Conforming Building:

A building or a portion thereof, lawfully existing at the effective date of this Resolution or amendments thereto and that does not conform to the provisions of the Resolution in the district in which it is located.

Non-Conforming Use:

A use which lawfully occupied a building or land at the effective date of this Resolution or amendments thereto and that does not conform to the use regulations of the district in which it is located.

Nude:

Nude or state of nudity shall mean the showing, representation or depiction of human male or female genitals, a bare buttock, an anus, or the areola or nipple of a female breast with less than a full, opaque covering of any portion thereof below the top of the nipple.

Nude Model Studio:

Nude Model Studio shall mean any place where a person, who regularly appears in a state of nudity or displays specified anatomical areas to be observed, sketched, drawn, painted, sculpted, photographed, or similarly depicted by other persons. This does not include accredited educational facilities. It is a defense to a prosecution for any violation of this Zoning Resolution that a person appearing in a state of nudity did so in a modeling class operated

1. in a structure which has no sign visible from the exterior of the structure and no other advertising that indicates a nude person is available for viewing;

2. where in order to participate in a class a student must enroll at least three days in advance of the class; and
3. where no more than one nude model is on the premises at any one time.

Nursery:

1. Plant Material:
A space, including accessory building or structure, for the growing, storage, and sales of live trees, shrubs or plant materials grown on the premises.
2. Retail:
A space including accessory building or structure, or combination thereof, for the storage of live trees, shrubs or plants offered for retail sale on the premises, including products used for gardening or landscaping.
3. Child Care:
A building used for the commercial care of five (5) or more children who are not members or wards of the owner of his immediate family. All child care nurseries shall possess an appropriate license from the Ohio Department of Human Services as required

Off-Street Parking Lot:

A facility providing vehicular parking spaces, along with adequate drives and aisles, for maneuvering, so as to provide access for entrance and exit.

Official Thoroughfare Plan:

The Official Thoroughfare Plan of Greene County, Ohio, establishing the official right-of-way width of major streets on file in the office of the Recorder of Greene County, Ohio, and in the office of the Regional Planning and Coordinating Commission of Greene County, Ohio, together with all amendments thereto subsequently adopted.

One Year Capture Area:

The scientifically delineated area within the one-year groundwater time-of-travel contour surrounding public water supply well field. Boundaries of the one-year capture area define the boundaries of the Well Field Protection Overlay District.

Open Space:

That part of a round lot, including courts or yards, which is open and unobstructed from its lowest level to the sky, accessible to all tenants upon the zoned lot.

Open Space (Common):

That area either dedicated to the public or commonly owned and/or available to all the residents of a Planned Unit Development Area.

Open Storage:

Storing or keeping of chattel not enclosed in a building.

Outdoor Amphitheater:

Outdoor theatrical setting sloping down to a stage for the purpose of spectator sports, concerts, rallies or theatrical performances.

Outdoor Recreation Facility:

Public owned and operated buildings and facilities: public parks, playgrounds, and community centers; public or private recreation areas, including country clubs, golf courses; public and private forests and wildlife preserves; swimming pools, provided they are located five hundred (500) feet from any residential district and two hundred (200) feet from any other district.

Parking Space:

A minimum of two hundred (200) square feet, said area shall be exclusive of drives, aisles or entrances giving access thereto, and shall be fully accessible for the storage or parking of permitted vehicles.

Peak Sound Pressure Level:

The maximum instantaneous sound pressure level that occurs.

Person:

Any individual, public or private corporation, political subdivision, governmental agency, department or bureau of the state, municipality, industry, co-partnership, association, firm, trust, estate or any other legal entity whatsoever.

Planned-Unit Development:

Land under unified control, planned and developed as a whole according to comprehensive and detailed plans, including streets, utilities, lot or building sites, site plans for all buildings as intended to be located, constructed and improvements on the land as related to buildings. Development may be a single operation or a definitely programmed series of development operations including all lands and buildings, with a program for provision, operation and maintenance of such areas, improvements and facilities necessary for common use by the occupants of the development.

Planning Commission:

The Regional Planning and Coordinating Commission of Greene County, Ohio.

Prime Agricultural Soils:

Prime agricultural soils are those soils within Xenia Township which display characteristics well-suited to agricultural activities such as field crops under normal or typical management practices. It has been determined through studies that the following soil types, as described in the Soil Survey of Greene County, Ohio (U.S. Department of Agriculture, 1974) are prime agricultural soils:

Ag	Algiers Silt Loam	OcA	Ockley Silt Loam (0to 2 percent slopes)
BbB	Birkbeck Silt Loam (1 to 4 percent slopes)	OcB	Ockley Silt Loam (2 to 6 percent slopes)
Bs	Brookston Silty Clay Loam	OcB2	Ockley Silt Loam (2 to 6 percent slopes, moderately eroded)
Bt	Brookston - Urban Land Complex	OdB	Ockley Urban Land Complex (undulating)
CeA	Celina Silt Loam (0 to 2 percent slopes)	OeB	Odell Silt Loam (2 to 6 percent slopes)
CeB	Celina Silt Loam (2 to 6 percent slopes)	Pa	Patton Silty Loam
CrA	Crosby Silt Loam (0 to 2 percent slopes)	Ra	Ragsdale Silty Clay Loam
CrB	Crosby Silt Loam (2 to 6 percent slopes)	RdA	Raub Silt Loam (0 to 2 percent slopes)
EdB	Edenton Silt Loam (2 to 6 percent slopes)	RdB	Raub Silt Loam (2 to 6 percent slopes)
Ee	Eel Loam	ReA	Reesvile Silt Loam (0 to 2 percent slopes)
EmA	Eldean Silt Loam (0 to 2 percent slopes)	Rs	Ross Loam
EmB	Eldean Silt Loam (2 to 6 percent slopes)	RtA	Rush Silt Loam (0 to 2 percent slopes)
EmB2	Eldean Silt Loam (2 to 6 percent slopes, moderately sloped)	RtB	Rush Silt Loam (2 to 6 percent slopes)
FnA	Fincastle Silt Loam (0 to 2 percent slopes)	RuA	Russell Silt Loam (0 to 2 percent slopes)
Gn	Genesse Loam	RvB	Russell-Miamian Silt Loams (2 to 6 percent slopes)
Ln	Linwood Muck	RvB2	Russell-Miamian Silt Loams (2 to 6 percent slopes)
MnA	Miamian Silt Loam (0 to 2 percent slopes)	S1A	Sleeth Silt Loam (0 to 2 percent slopes)

MnB	Miamian Silt Loam (2 to 6 percent slopes)	ThA	Thackery Silt Loam (0 to 2 percent slopes)
MhB2	Miamian Silt Loam (2 to 6 percent slopes, moderately eroded)	ThB	Thackery Silt Loam (2 to 6 percent slopes)
MoB2	Miamian-Eldean Silt Loams (2 to 6 percent slopes, moderately eroded)	WaA	Warsaw Loam (0 to 2 percent slopes)
MrB	Miamian Urban Land Complex (undulated)	WeB	Wea Silt Loam (1 to 3 percent slopes)
MtA	Milton Silt Loam (0 to 2 percent slopes)	Ws	Westland Silty Clay Loam
MtB	Milton Silt Loam (2 to 6 percent slopes)	XeA	Xenia Silt Loam (0 to 2 percent slopes)
		XeB	Xenia Silt Loam (2 to 6 percent slopes)

Principal Building:

A non-agricultural building in which is conducted the main or principal use of the lot on which said building is located ordinarily the largest building on the lot, and ordinarily the use conducted on the first story of such building above the basement.

Principal Use:

The main use to which the premises are devoted and the main purpose for which the premises exist.

Public Utility:

Any person, firm, or corporation, municipal department, board or commission duly authorized to furnish and furnishing under state or municipal regulations to the public: gas steam, electricity, sewage disposal, communications, telegraph, telephone, transportation or water.

Recreational Vehicle:

Any motor vehicle designed or intended to be used primarily for short-term dwelling or sleeping purposes away from the place of residence of the occupants; and not constituting the principal place of residence of the occupants.

Regulated Substances:

Substances to be regulated, hereinafter referred to as Regulated Substances, are chemicals and mixtures of chemicals that are health hazards in groundwater as determined by the most recent revision of Public Drinking Water Standards for Ohio.

Research Activities:

Research, development and testing related to such fields as chemical, pharmaceutical, medical, electrical, transportation, and engineering. All research, testing, and development shall be carried on within entirely enclosed buildings, and no noise, smoke, glare, vibration, or odor shall be detected outside such building.

Restaurant:

An establishment whose primary business is serving food and beverage to patrons for consumption inside the building.

Riding Academies:

Facilities designed or used for the renting of horses and/or the instruction of horse riding, including any barns, exercise areas, and field areas to be used in the operation.

Road Frontage:

Will be determined at the road right-of-way line as recorded in the county records.

Row House or Town House:

A two (2) story row of three (3) or more attached one (1) family dwellings, each unit of which extends from the basement to the roof.

Rural Entertainment and Hospitality:

A private business enterprise for the purpose of offering a venue for a fee for non-public events on agricultural property that includes non-agriculturally related activities such as: barn dances, weddings, receptions, official or formal ceremonies, social gatherings, family reunions, campfires, picnics or retreats. Such activities shall take place between the hours of 9:00 a.m. and 11:00 p.m., not more than twelve (12) days a month, and for no more than three (3) consecutive days.

Semi-Nude:

Semi-nude shall mean a state of dress in which clothing covers no more than the genitals, the pubic region and the areola of the female breast, as well as portions of the body covered by supporting straps or devices.

Setback Line:

A line parallel to a lot line, at any story level of a building which defines the limits of a yard and represents the distance which all or any part of a building or structure is to be set back from said lot line, street, or right-of-way line.

1. Front Setback Line: An imaginary line parallel to the front lot line extending the full width of the lot, representing the distance which all or any part of any structure or building is to be set back from the front lot line. In the event that the front lot line does not fall along a right-of-way line, then the front setback line shall be measured from a line parallel to and twenty-five (25) feet from the centerline of the street. (See illustration)
2. Side Setback Line: An imaginary line parallel to any side lot line representing the distance which all or any part of any principal building is to be set back from the side lot line. (See illustration)
3. Rear Setback Line: An imaginary line parallel to any rear lot line representing the distance which all or any part of any principal buildings is to be set back from the rear lot line.

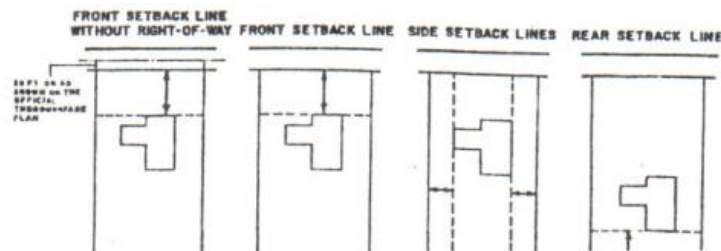

Sewage Disposal System, Central:

A wastewater treatment system approved by the appropriate county, state, and/or federal agencies which provides a collection network and a central wastewater treatment facility for a single development, a community, or a region.

Sewage Disposal System, On-Site:

A septic tank or similar installation on an individual lot which utilizes an aerobic or anaerobic bacteriological process or equally satisfactory process for the treatment of sewage and provides for the proper and safe disposal of the effluent, approved by the appropriate county, state, and/or federal agencies.

Sign:

A name, identification, description, display or illustration which is affixed to, painted, or represented, directly or indirectly upon a building, structure, parcel or lot and which directs attention to an object, product, place, activity, person, institution, organization or business, excluding licensed vehicles.

Sign (Electronic):

A sign with a fixed or changing display or message which may be changed by electronic means.

Sign (Face):

The area of a sign containing a single message. If a message area can be divided in such a way that the messages in each sub-area have the same meaning when viewed in isolation as when viewed with the full area, then each sub-area is a separate sign face. For signs with a supporting structure, the area shall be defined by a rectangular area outlining the text or image.

Sign (Full Motion Video):

Changes in illumination to create the illusion of motion which is not repetitive.

Sign (Illuminated):

A sign that is brightened with an artificial light source whether illumination is emitted, reflected or indirect.

Sign (Repetitive Animation):

Actual motion, or changes in illumination to create the illusion of motion, which is repetitive and/or rotational and has a frequency of less than 2 Hz.

Sign (Strobe):

Perceptible periodic change in luminance with a frequency of 2 Hz or greater.

Sign (Temporary):

A freestanding sign that does not occupy a permanent location on the ground. These signs must also comply with the district and road frontage requirements.

Sound:

Mechanical radiant energy that is transmitted by longitudinal pressure waves in air or other material medium and is the objective cause of hearing.

1. "IMPULSIVE SOUND" means noise characterized by brief excursions of sound pressure (acoustic impulses) which significantly exceed the ambient environmental sound pressure, the duration of a single impulse being usually less than one second.
2. "CONTINUOUS SOUND" means noise whose level remains essentially consistent (i.e. fluctuations are negligibly small) during the period of observation.

Sound Level:

A weighted sound pressure level, obtained by the use of metering characteristics.

Sound Source Site:

A fixed geographic location that consists of all contiguous land and water areas under ownership or control of a person. The sound source site includes all individual sources of sound that are located on the site, both stationary and movable.

Specified Anatomical Areas:

Specified Anatomical Areas shall mean less than completely and opaquely covered human genitals, pubic region, buttock and female breasts below a point immediately above the top of the areola.

Specified Sexual Activities:

Specified Sexual Activities shall mean acts, real or simulated, of human fondling, sexual intercourse, sodomy, cunnilingus or fellatio; or the fondling or other erotic touching of human genitals, the pubic region, a buttock or female breasts.

Stock In Trade:

Stock In Trade shall mean the total volume or number of items products, or equipment available for purchase, rental, viewing or use by patrons of the establishment, excluding material located in any storeroom or other portion of the premises not regularly open to patrons.

Store & Lock/Mini-warehouse Facility:

A building or group of buildings in a controlled access compound that contains varying sizes of individual, compartmentalized and controlled access stalls or lockers for the storage of customer's goods or wares.

Story:

That part of a building, except a mezzanine as defined herein, included between the surface of one floor and the surface of the next floor, or if there is not floor above, then the ceiling next above. If the floor level directly above a basement is more than six (6) feet above grade, such basement shall be considered a story.

Story (Half):

An uppermost story lying under a sloping roof having an area of at least two hundred (200) square feet with a clear height of seven feet six inches (7'6"). For the purposes of this Resolution, the useable floor area is only that area having at least four feet (4') clear height between floor and ceiling.

Street:

A public thoroughfare which affords the principal means of access to abutting property:

1. Street, Private: An improved street or roadway which has not been dedicated for public use, or accepted by the Xenia Township Board of Trustees and is not maintained by the Township. In addition, a private street must meet the specifications established by, and approved under the Subdivision Regulations for Greene County, Ohio.
2. Street, Public: An improved street or roadway which has been constructed to Greene County Subdivision Regulations, dedicated for public use and accepted by the Xenia Township Board of Trustees and maintained by the Township. When built, a street shall be a public street when included in the official thoroughfare plan for Greene County, Ohio.

Structure:

Anything constructed or erected, the use of which requires permanent location on the ground or attachment to something having permanent location on the ground.

Swimming Pool:

Any artificially constructed pool or natural body of water which contains a depth of water of at least 1 1/2 feet at any point used or intended to be used for swimming or bathing, including any accessory recreational structures.

Swimming Pool, Public:

Any swimming pool, other than a private pool, which is the principal use upon a lot and operated with or without a charge for admission.

Swimming Pool, Private:

A swimming pool located on the same lot as the principal use and used or intended to be used without compensation by the residents and guests of a single-family residence, a two-family residence, a multi-family development, or a motel.

Temporary Use or Building:

A use or building permitted to exist during periods of construction of the main building or use, or for special events.

Tenant Farm Dwelling:

A dwelling unit constructed or occupied for the purpose of providing housing for a tenant farmer and his family who are engaged in assisting the owner in the practice of agriculture and/or maintenance of his farm.

Tent:

Any portable shelter constructed wholly or in part from canvas, tarpaulin or other similar materials.

Thoroughfare, Street, or Road:

The full width between property lines bounding every public way of whatever nature, with a part thereof to be used for access to a property by vehicular traffic and designated as follows:

1. Alley: A minor street used primarily for vehicular service access to the back or side of properties abutting on another street.
2. Arterial Street: A general term denoting a highway primarily for through traffic carrying heavy loads and large volumes of traffic, usually on a continuous route.
3. Collector Street: A thoroughfare, whether within a residential, industrial, commercial, or other type of traffic development, which primarily carries traffic from local streets to arterial streets, including the principal entrance and circulation routes within residential subdivisions.
4. Cul-de-sac: A local street of relatively short length with one end open to traffic and the other end permanently terminating in a vehicular turn around
5. Dead-End Street: A street having only one outlet for vehicular traffic and intended to be extended or continued in the future.
6. Local Street: A street primarily for providing access to residential, commercial, or other abutting property.
7. Loop Street: A type of local street, each end of which terminates at an intersection with the same arterial or collector street and whose principal radius points of the one hundred and eighty (180) degree system or turns are not more than six hundred (600) feet from each other.
8. Marginal Access Street: A local or collector street, parallel to and adjacent to an arterial or collector street, providing access to abutting properties and protection from arterial or collector streets. (Also called Frontage Street)

Tower:

A self-supporting lattice, guyed or monopole structure constructed from grade.

Tower Height:

Is the vertical distance measured from the established grade to the highest point of the tower including all attached equipment in any operating configuration. Where the tower is located on sloping terrain, the height shall be measured from the average ground level at the base of the tower.

Township Enforcement Officer:

The Township Enforcement Officer or his/her authorized representative, appointed by the Township Trustees of Xenia Township, Greene County, Ohio

Township Trustees:

Means the Board of Township Trustees of Xenia Township, Greene County, Ohio.

Township Zoning Commission:

Means the Zoning Commission of Xenia Township, Greene County, Ohio.

Trailer (Recreational Vehicle):

Includes Travel Trailer, Campers, Camp Car, Truck Campers, Boats and Boat Trailers.

Underground Storage Tank:

An underground storage tank is one or a combination of tanks (including underground pipes connected thereto) which is used to contain an accumulation of Regulated Substances and the volume of which (including the volume of underground pipes connected thereto) is ten (10) percent or more beneath the surface of the ground. The term Underground Storage Tank does not include any of the following:

1. Pipeline facilities, including gathering lines, regulated under the Natural Gas Pipeline Safety Act of 1968, 82 Stat. 720, 49 U.S.C.A. 2001, as amended;
2. Surface impoundments, pits, ponds, or lagoons;
3. Storm or waste water collection systems;
4. Flow-through process tanks;
5. Storage tanks located in underground areas when the tanks are located on or above the surface of the floor and the integrity of the tank is periodically visually evaluated;
6. Septic tanks; and
7. Tanks equal or less than five hundred (550) gallons used for storing heating fuel for consumptive use on the premises where stored provided the premises are single-family or two-family residences.

Use:

The purpose for which land or a building is arranged, designed or intended, or for which land or a building is or may be occupied.

Variance:

A modification of the literal provisions of the Zoning Resolution granted when strict enforcement of the Zoning Resolution would cause undue hardship owing to circumstances unique to the individual property on which the variance is granted.

Veterinary Animal Hospital or Clinic:

A place used for the care, grooming, diagnosis, and treatment of sick, ailing, infirm, or injured animals, and those who are in need of medical or surgical attention. Such use may include overnight accommodations on the premises for treatment, observation, and/or recuperation.

Vicinity Map:

A drawing which sets forth by dimensions or other means the relationship of a property or use to other nearby developments of landmarks and community facilities and services within Xenia Township in order to better locate and orient the area in question.

Water System, Central:

A water supply system approved by the appropriate county, state, and/or federal agencies which provides a water supply to a single development, a community, or a region.

Water System, On-Site:

A well or other similar installation on an individual lot which provides a water supply to any structures or uses upon the lot, subject to the approval of health and sanitation officials having jurisdiction.

Wireless Telecommunications Facility:

Any cables, wires, lines, wave guides, antennas and any other equipment or facilities associated with the transmission or reception of communications as authorized by the FCC which a person seeks to locate or have installed upon a tower antenna support structure. However, the term wireless telecommunications facilities shall not include:

1. Any satellite earth station antenna two (2) meters in diameter or less which is located in an area zoned industrial or commercial.
2. Any satellite earth station antenna one (1) meter or less in diameter, regardless of zoning category.
3. Antennas used by amateur radio operators.

Yards:

The open spaces on the same lot with a main building, unoccupied and unobstructed from the ground upward except as otherwise provided in this Resolution as defined herein.

1. Front yard: Is an open space extending the full width of the lot, the depth of which is the minimum horizontal distance between the front lot line and the nearest point of the main building. (See illustration).
2. Rear yard: Is an open space extending the full width of the lot the depth of which is the minimum horizontal distance between the rear lot line and the nearest point of the main building. (See illustration)
3. Side yard: Is an open space between a main building and the side lot line, extending from the front yard to the rear yard, the width of which is the horizontal distance from the nearest point of the side lot line to the nearest point of the main building. (See Illustration)

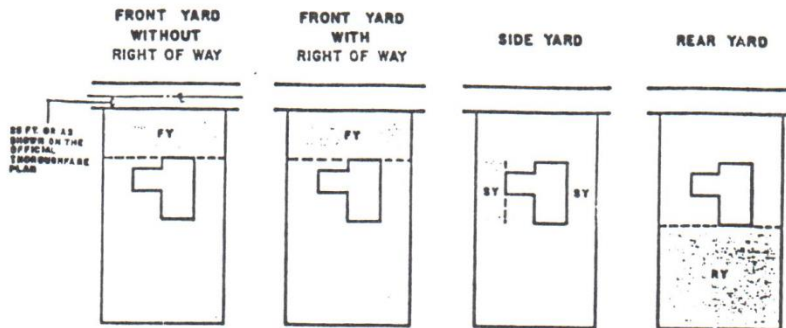

Zoning Certificate:

A zoning certificate is a written statement issued by the Zoning Inspector authorizing the construction of buildings, structures, or the establishment of uses permitted in this Resolution. If at the end of a twelve (12) month period from the date of issuance of permit the construction is not completed, the person or persons involved must reapply for the zoning certificate or be granted an extension of time, or be deemed in violation of the Zoning Resolution.

Zoning Commission:

The Zoning Commission of Xenia Township, Greene County, Ohio.

Zoning Inspector:

The Zoning Inspector or his/her authorized representative, appointed by the Township Trustees of Xenia Township, Greene County, Ohio.

Zoning Map:

The Official Zoning District Map of Xenia Township, or portion thereof, together with all amendments thereof subsequently adopted.

Zoning Permit:

A document issued by the Zoning Inspector certifying that the use of a lot, structure, or building or location of a structure or building upon a lot is in conformance with this Resolution.

ARTICLE III - ZONING DISTRICTS AND MAP

SECTION 300 - DISTRICTS

In order to carry out the intent and purpose of this Resolution, Xenia Township is hereby divided into the following districts:

- A AGRICULTURAL DISTRICT
- E RURAL SUBURBAN RESIDENTIAL ESTATE DISTRICT
- R-1 ONE FAMILY RESIDENTIAL DISTRICT
- R-M MULTI-FAMILY RESIDENTIAL DISTRICT
- IG INSTITUTIONAL AND GOVERNMENTAL DISTRICT
- B-1 CONVENIENCE SHOPPING DISTRICT
- B-2 NEIGHBORHOOD BUSINESS DISTRICT
- B-3 HIGHWAY BUSINESS DISTRICT
- M-1 RESTRICTED OR LIGHT INDUSTRIAL DISTRICT
- M-2 HEAVY INDUSTRIAL DISTRICT
- M-3 MINERAL PROCESSING AND STORAGE DISTRICT
- F-1 FLOOD PLAIN OVERLAY
- WP WELL FIELD PROTECTION OVERLAY
- PUD PLANNED UNIT DEVELOPMENT
- R-MH MOBILE HOME PARK

SECTION 301 - DISTRICT BOUNDARIES

The boundaries of the zoning districts listed above in Section 300 are shown on the "Zoning Map of Xenia Township, Greene County, Ohio." This map together with all explanatory data thereon, including all changes thereof as hereinafter provided, shall be incorporated and made a part of this Resolution.

The official zoning map shall be identified by the signature of the Township Trustees attested by the Township Clerk, and bearing the seal of the Township under the following words: This is to certify that this is the official zoning map of the Zoning Resolution of Xenia Township, Greene County, Ohio (including date of adoption). If, in accordance with the provisions of this Resolution, changes are made in district boundaries or other matter portrayed on the official zoning map, such changes shall be made on the official zoning map within five (5) normal working days after the amendment has been approved by the Township Trustees together with an entry on the official zoning map as follows: "On (date), by official action of the Township Trustees, the following change(s) were made" (brief description with reference number to Trustees' proceedings).

The original and one copy of the official map are to be maintained and kept up to date - one copy on public display in the Township Building and the original in the Clerk's office - accessible to the public, and shall be final authority as to the current zoning status of lands, buildings, and other structures in the Township.

SECTION 302 - UNCERTAINTY OF BOUNDARY LOCATION

Where uncertainty exists with respect to the boundaries of the various districts as shown on the Zoning Map, the following rules shall apply:

1. Boundaries indicated as approximately following the center lines of streets, highways, or alleys shall be construed to follow such center lines;
2. Boundaries indicated as approximately following platted lot lines shall be construed as following such lot lines;
3. Boundaries indicated as approximately following municipal limits shall be construed as following municipal limits;
4. Boundaries indicated as following railroad lines shall be construed to be the midway between the main tracks;
5. Boundaries indicated as following shore lines shall be construed to follow such shore lines, and in the event of change in the shore line shall be construed as moving with the actual shore line; boundaries indicated as approximately following the center line of streams, rivers, canals, lakes, or other bodies of water shall be construed to follow such center lines;
6. Boundaries indicated as parallel to or extensions of features indicated in subsections 1 through 5 above shall be so construed. Distances not specifically indicated on the Official Zoning Map shall be determined by the scale of the map;
7. Where physical or manmade features existing on the ground are at variance with those shown on the Official Zoning Map, or in other circumstances not covered by subsections 1 through 6 above, the Board of Appeals shall interpret the district boundaries.

ARTICLE IV - DISTRICT REGULATIONS

SECTION 400 - A - AGRICULTURAL DISTRICT

(Subject to Section 412 Flood Overlay and Section 413 Well Field Overlay)

400.1 Intent and Purpose

The intent of the Agricultural District is to recognize the long-range physical, social and economic needs of the agricultural community within Xenia Township. Since agricultural pursuits provide a substantial economic base for Xenia Township and many areas still exist which possess an existing agricultural character and prime agricultural soils, it is the intent of this district to maintain and protect such areas. Only those land uses which perform necessary functions within the agricultural community will be encouraged to locate within the Agricultural District. The intent is that the principal use for land in this category is agriculture as defined in Agriculture. Unnecessary encroachment by nonagricultural land uses which limits agricultural effectiveness either through encroachment of land resources or through incompatibility of land uses will be discouraged.

400.2 Permitted Principal Uses

1. Agricultural purposes
2. One primary single-family dwelling.
3. Temporary buildings for uses incidental to construction work, to be removed upon completion of said work;
4. Churches and parish houses.

400.3 Accessory Uses

Refer to Article II, Section 201 Accessory Use or Building.

400.4 Conditional Uses

The following uses are allowed in any A-1 Agricultural District provided a conditional use is granted by the Board of Appeals as provided in Article VI, Section 600.8 of this Resolution:

1. Public owned and operated buildings and facilities: public parks, playgrounds, and community centers; public or private recreation areas, including country clubs, golf courses; public and private forests and wildlife preserves; swimming pools, provided they are located five hundred (500) feet from any residential district and two hundred (200) feet from any other district;
2. Cemeteries, provided they are located at least two hundred (200) feet from adjacent property lines and provided further, that no cemetery will be less than forty (40) acres in area;
3. Loud speakers, jukeboxes, public address systems, and electric amplifiers, if the use of the same is for the occupants of the building only; and if such equipment does not create a nuisance and does not disturb the peace of the neighborhood;
3. Bed and Breakfast
4. Public or privately owned and operated airports or landing fields shall be in accordance with the following requirements;
 - a. In order to maintain the safety of the occupants of surrounding properties, all private helicopter landing areas shall be located a minimum of one thousand feet from any adjacent property or shall be screened by wall, solid fence, mound or evergreen planting a minimum of six (6) feet in height. In order to maintain the safety of the occupants of surrounding properties, all such sites shall be approved by the Ohio Department of Transportation, Division of Aviation.

- b. All private landing strips shall be approved by the Ohio Department of Transportation, Division of Aviation and shall be situated so as to not create a nuisance or hazard to residential dwellings or other structures within the vicinity.
- 6. Disposal of garbage or refuse by a county, township, or a municipal corporation.
- 7. Veterinary Animal Hospital or Clinic.
- 8. Commercial Recreational Facilities.
- 9. Tenant Farmer Dwelling: A Zoning Permit is not required for the erection of a tenant farmer dwelling (s) provided the land owner/lessee states in writing to the Zoning Inspector that the singular and continuing purpose of the dwelling is constructed or occupied for the purpose of providing housing for the tenant farmer and his family who are engaged in assisting the owner in the practice of agriculture and/or maintenance of his farm.
- 50. Feed lots as defined in Section 201, however, no feed lot shall be approved by the Board of Zoning appeals on parcels less than twenty acres.
- 11. Private schools, institutions of higher learning.
- 12. Rural Entertainment and Hospitality
- 13. Agritourism

400.5 Height Regulations

No building shall exceed two and one-half stories or thirty-five (35) feet in height.

400.6 Yard Residence Frontage and Requirements

As defined in Schedule of Yard and Lot Requirements (Article 404).

400.7 Maximum Percentage of Lot Coverage

15%

400.8 Signs

Refer to Article V, Section 517.

400.9 Accessory Parking

For parking space required by use see Article V, Section 514.

400.10 Screening. See section 515 for screening regulations for uses adjoining residential districts.

SECTION 401 - E - RURAL SUBURBAN RESIDENTIAL ESTATE DISTRICT

(Subject to Section 412 Flood Overlay and Section 413 Well Field Overlay District)

401.1 Intent and Purpose

Estate zoning provides low density residential development with a minimum tract size of three acres in outlying rural areas where urbanization and the extension or creation of central water supply and waste water disposal systems are either not appropriate or not expected to occur for an extended period of time into the future. An Estate District may not be less than 30 acres, although zoning of smaller areas (including individual tracts) can be considered if evidence is presented that such revision of land use is consistent with available natural resources (water supply and waste water disposal capability).

401.2 Permitted Principal Uses

1. Single family dwelling;
2. Public community center buildings, parks, playgrounds and golf courses except miniature golf courses;
3. Planned Unit Development per Section 414.

401.3 Accessory Uses

Refer to Article II, Section 201 Accessory Use or Building: Is a use or building on the same lot with, and of a nature customarily incident and subordinate to those of the main use or building.

401.4 Conditional Uses

The uses allowed in any E - Rural Suburban Residential Estate District provided a conditional use is granted by the Board of Appeals as provided in Article VI, Section 600.8 this Resolution, and further provided that all buildings allowed by such conditional use permit shall be set back from all lot lines a minimum of three feet for each one foot of building height.

1. Recreation areas or buildings operated by membership clubs for the benefit of their members and not for gain; provided any principal building, accessory building, or out-of-door swimming pool shall be located not nearer than 200 feet from any adjoining land zoned for a Residential Use.
2. Community Center
3. Private schools, institutions of higher learning.
4. Cemeteries, when extensions of existing cemeteries.
5. Planned development (See Article IV, Section 414).
6. Churches and similar places of worship: provided such use is adjacent to a school or commercial area and/or access is by means of roads designated as primary or secondary thoroughfares by the Major Street Plan;
7. Agritourism

401.5 Yard Requirements

See Article IV, Section 404 Schedule of Yard and Lot Requirements.

401.6 Building Height Requirements

No building shall be erected in excess of 2 1/2 stories or thirty-five (35) feet in height.

401.7 Accessory Parking

Two (2) car spaces for each dwelling unit. Parking for other uses: Article V, Section 514.2
Off-street

401.8 Signs

Refer to Article V, Section 517.

401.9 Maximum Percentage of Lot Coverage

15%

SECTION 402 R-1 - ONE-FAMILY RESIDENTIAL DISTRICT

(Subject to Section 412 Flood Overlay and Section 413 Well Field Overlay)

402.1 Intent and Purpose

These districts are the most restrictive of the residential districts. The intent is to provide for an environment of low-density single unit dwellings with an average of one dwelling per one half (1/2) acre without the requirement of sidewalks, curbs and gutters, etc., plus certain other facilities which serve the residents living in the district. Central water supply and waste water disposal facilities are required to avoid development of health and safety hazards for land placed in this District. A Residential District shall be not less than 50 acres, with no consideration for zoning of smaller tracts. It is strongly recommended that such developments be Planned Unit Developments per Section 414.

402.2 Permitted Principal Uses

1. Single family dwelling unit;
2. Parks, playgrounds and golf courses except miniature golf courses;

402.3 Accessory Uses

Refer to Article II, Section 201 Accessory Use or Building: Is a use or building on the same lot with, and of a nature customarily incident and subordinate to, those of the main use or building.

402.4 Conditional Uses

The following uses are allowed in any R-1 Residential District provided a conditional use permit is granted by the Board of Appeals as provided in Article VI, Section 600.8 of this Resolution, and further provided that all buildings allowed by such Conditional Use permit shall be set back from all lot lines a minimum of three feet (3') for each one foot (1') of building height.

1. Recreation areas or buildings operated by membership clubs for the benefit of their members and not for gain; provided that any principal building, accessory building or out-of-doors swimming pool shall be located not nearer than 200 feet from any adjoining land zoned for a residential area.
2. Community Center
3. Cemeteries, when extension of existing cemeteries.
4. Planned development. (See Article IV, Sec. 414)
5. Churches and similar places of worship provided such use is adjacent to a school or commercial area and/or access is by means of roads designated as primary or secondary thoroughfares by the Major Street Plan.
6. Agritourism

402.5 Yard Requirements

See Section 404.

402.6 Building Height Regulations

In any R-1 Residential District no building shall be erected in excess of 2 1/2 stories or thirty-five feet (35') in height.

402.7 Accessory Parking

Two (2) car spaces for each dwelling unit. Parking for other uses Article V, Section 514.2 Off-street.

402.8 Signs

Refer to Article V, Section 517.

402.9 Maximum Percentage of Lot Coverage

15%

SECTION 403 - RM-MULTI-FAMILY RESIDENTIAL DISTRICT

(Subject to Section 412 Flood Plain Overlay and Section 413 Well Field Overlay)

403.1 Intent and Purpose

The intent of this district is to provide for both two-family and multiple-family residential development. Necessary services and accessory uses compatible with medium-high density residential surroundings are encouraged. This district should only be encouraged at locations which possess adequate access to schools, employment areas, shopping facilities and other community services via major streets without passage through areas of lower density. Central water and sewer facilities are required for land placed within this district to avoid development of health and safety hazards. It is strongly recommended that such developments be Planned Unit Developments per Section 414.

403.2 Permitted Principal Uses

1. Multiple dwellings - Apartments, Condominiums, Row Houses, Townhouses, etc.

403.3 Accessory Uses

Refer to Article II, Section 201 Accessory Use or Building: Is a use or building on the same lot with, and of a nature customarily incidental and subordinate to, those of the main use or building.

403.4 Conditional Uses

The following uses are allowed in any R-M Multi-Family Residential District provided a conditional use permit is granted by the Board of Appeals as provided in Article VI, Section 608 of this Resolution.

1. Dormitories and Group Housing;
2. Fraternities, Sororities, Clubs, Lodges, Social or Recreational Buildings or properties not for profit;
3. Churches and similar places of worship;
4. Community Center.
5. Agritourism

403.5 Yard Requirements

See Article IV, Sec. 404 - Schedule of Yard and Lot Requirements.

403.6 Building Height Regulations

In any R-M District no building shall be erected in excess of three (3) stories or forty-five (45) feet in height.

403.7 Accessory Parking

For parking space required for other than residential uses see Article V, Section 514.2.

403.8 Signs

See Article V, Section 517 for size and location of permitted signs.

403.9 Maximum Percentage of Lot Coverage

15%

SECTION 404 - SCHEDULE OF YARD AND LOT REQUIREMENTS ZONING DISTRICTS AND DWELLINGS

DISTRICT	MIN. LOT AREA PER FAMILY	MIN. ROAD FRONTAGE	MIN. FRONT YARD SET-BACK	MIN. REAR YARD SET-BACK	MIN. SIDE YARD SET-BACK	SUM OF SIDES SET-BACK MIN.	MIN. LIVING AREA PER UNIT SQ. FT.	WATER, SEPTIC & SEWER FACILITIES
A	5 Acres (1) (3)	300 ft.	70	40	40	80	1800	ON-SITE
E	3 Acres	150 ft.	50	40	20	40	1800	ON-SITE
R-1	½ acre	150 ft.	40	40	10	25	1800	OFF-SITE
R-M	2/1 Ratio	Unit to green space					900	ON-SITE

1. Corner lots setbacks shall require the same frontage per street.
2. Maximum height of buildings shall be thirty-five (35) feet and 2 ½ stories high.
3. A minimum of 1,000 square feet living area shall be bounded by the foundation in all districts except R-M District.
4. Minimum lot road frontage for a “cul-de-sac” lot width will be determined at the setback line.

SECTION 405 - IG - INSTITUTIONAL AND GOVERNMENTAL DISTRICT

(Subject to Section 412 Flood Overlay and Section 413 Well Field Overlay)

405.1 Intent and Purpose

This district is provided for the use of educational institutions, hospitals, residential social service facilities, and other institutions of a religious charitable or philanthropic or governmental agency nature. A minimum land area of one (1) acre if central water supply and offsite waste disposal are available or three (3) acres if they are not available. It is strongly recommended that such developments be Planned Unit Developments per Section 414.

405.2 Permitted Principal Uses

Public uses, semi-public uses, public service facility, essential services and accessory uses.

1. Churches and similar places of worship, parish houses, convents in conjunction with churches or schools, schools and colleges for academic instruction;
2. Convalescent or Nursing Homes.
3. Hospitals, clinics & Sanitariums for human care;
4. Public libraries;
5. Community Center.

405.3 Accessory Uses

Refer to Article II, Section 201 Accessory Use or Building: Is a use or building on the same lot with and of a nature customarily incidental and subordinate to, those of the main use or building.

405.4 Conditional Uses

1. Agriculture and Airports
2. Agritourism

405.5 Yard Requirements

Those yard requirements of the adjacent and surrounding Residential, B-2 and B-3 Districts.

405.6 Building Height Regulations

Maximum permitted height for buildings in this District shall be 45 feet.

405.7 Maximum Percentage of Lot Coverage

15%

405.8 Minimum Lot Size

1 Acre.

405.9 Minimum Lot Frontage

250 Feet

SECTION 406 - B-1 - CONVENIENCE SHOPPING DISTRICT

(Subject to Section 412 Flood Overlay and Section 413 Well Field Overlay)

406.1 Intent and Purpose

This district is designed to provide for a limited range of convenience goods to supply the emergency needs of those living in the immediate vicinity

406.2 Permitted Principal Uses

1. Local retail business or service establishment such as:
 - a. grocery, fruit or vegetable store
 - b. meat market
 - c. drug store
 - d. shoe repair shop
 - e. hardware store
 - f. barber and beauty shop
 - g. clothes cleaning and laundry pick-up station
 - h. self-service automatic laundry and dry-cleaning shop
2. Business or office of recognized professions, or similar to the above list.
3. Convenience store including the sale of vehicular fuel, lubricants, coolants, and accessories, kerosene, and propane for recreational uses.
4. Community Center.

406.3 Accessory Uses

Refer to Article II, Section 201 Accessory Use or Building: Is a use or building on the same lot with, and of a nature customarily incident and subordinate to, those of the main use or building.

406.4 Yard Requirements

Those yard requirements of the adjacent and surrounding Residential District

406.5 Building Height Regulations

Maximum permitted height for buildings in this district shall be 2 1/2 stories or 35 feet.
Maximum square footage - 2500 sq. ft.

406.6 Accessory Parking

Space shall be provided as required in accordance with the provision of Article V, Section 514.

406.7 Off-Street Loading

Spaces shall be provided as required in Article V, Section 513.

406.8 Signs

See Section 517 for size and location of permitted signs.

406.9 Screening

See Section 515 for screening regulations for uses adjoining residential districts.

406.10 Maximum Percentage of Lot Coverage

40%

406.11 Minimum Lot Size

Minimum land area of one half (1/2) acre if central water supply and offsite waste water disposal is available, or two (2) acres if they are not available.

406.12 Minimum Lot Frontage

100 Feet

SECTION 407 - B-2 - NEIGHBORHOOD BUSINESS DISTRICT

(Subject to Section 412 Flood Overlay and Section 413 Well Field Overlay)

407.1 Intent and Purpose

The purpose of this district is to provide for a variety of retail stores and related activities and for office buildings and service establishments which serve the convenience and service needs of the consumer population. Land to be placed in this district is intended to have level topography for safe ingress, egress and parking, public utilities, central water supply, offsite waste water disposal and major transportation facilities readily available.

407.2 Permitted Principal Uses

1. Any generally recognized retail business, service establishment, or uses as permitted in B-1 Convenience Shopping District, or as follows:
 - a. Apparel shops, including specialty shops of all sorts, shoe stores, and similar uses;
 - b. Auto service station, for only the sale of gas, lubricants, coolants, and accessories, and the performance of incidental service such as tire installation and automobile washing, cleaning and polishing, but not major overhaul, body work, or painting;
 - c. Auto wash (self-service);
 - d. Shops selling new or rebuilt automobile parts and accessories exclusively;
 - e. Banks, loan offices, stock exchange offices and other financial institutions;
 - f. Commercial recreation facilities such as bowling alleys and movie theaters;
 - g. Department stores;
 - h. Eating and drinking: restaurants, dairy bars or other places serving food and/or beverage;
 - i. Floral shop, fruit, nursery stock and produce sales;
 - j. Food stores including supermarkets and all types of specialty food stores such as bakeries, candy stores, and similar uses;
 - k. Furniture and appliances, including rugs, floor coverings, draperies, sewing machine shops, used furniture, office equipment, supplies, and similar uses;
 - l. Gift shops, camera shops, record shops, book and stationery stores, jewelry stores, and similar uses;
 - m. Hardware and related stores as paint, wallpaper, and similar uses;
 - n. Mortuaries;
 - o. Music, musical instrument stores (retail);
 - p. Newspaper, magazine and book stores (retail);
 - q. Nursery school; day care.
 - r. Office of architects, engineers and artists.
 - s. Office of surgeons, physicians, dentists and other similar professional persons concerned with the health and medical treatment of persons;
 - t. Offices in which the personnel will be employed for work in executive, administrative, legal, writing, clerical, stenographic, accounting insurance or similar enterprises;
 - u. Photographic studios;
 - v. Professional and other offices drawing a large number of clients and/or customers such as, but not restricted to:
 - (1) Chamber of Commerce, automobile clubs
 - (2) Doctors, dentists, lawyers, architects

- (3) Insurance, realtors, unions
- (4) Post Office
- (5) Utility Office
- w. Publishing and printing;
- x. Repair shops such as shoe and watch repair;
- y. Service shops such as barber, beauty, laundry, cleaned and similar uses including laundry pick-up service and coin operated washing and dry-cleaning facilities;
- z. Travel agencies;
- aa. Variety stores;
- 2. Public and semi-public buildings such as but not restricted to:
 - a. Churches
 - b. Fraternal organizations
 - c. Library
 - d. Municipal offices
 - e. Parking garage.
 - f. Community Center

407.3 Accessory Uses

Refer to Article II, Section 201 Accessory Use or Building: Is a use or building on the same lot with, and of a nature customarily incident and subordinate to, those of the main use or building.

407.4 Yard Requirements

In a B-2 Neighborhood Business District the following minimum yard areas shall be provided:

1. Front Yards: A 25-foot front yard shall be required, excepting where the frontage on one side of the block is divided between B-3 Highway Business District and a residential district, the front yard of the Residential District shall apply to the area in the B-3 Highway Business District.
2. Side Yards: Side yards shall not be required excepting:
 - a. A yard not less than 10 feet in width shall be provided where a side lot line of a neighborhood business district abuts a residential district.
 - b. In all other cases no side yard shall be required for a business, but if such a yard is voluntarily provided, it shall be not less than 6 feet in width.
3. Rear Yards: Rear yards shall not be required excepting where a rear lot line of a neighborhood business district abuts a residential district. In such instances, there shall be a rear yard of twenty-five (25) feet for a one or two-story building; such yard may be measured from the centerline of an intervening alley. An additional one (1) foot of rear yard shall be provided for each two (2) feet of height over twenty-five (25) feet.

407.5 Building Height Regulations

Maximum permitted height for buildings in this district shall be 2 1/2 stories or thirty-five (35) feet.

407.6 Accessory Parking

In a neighborhood business district parking shall be provided as required in Section 514 of this Resolution.

407.7 Off-Street Loading

Spaces shall be provided as required in Section 513 of this Resolution.

407.8 Signs

See Section 517 of this Resolution for size and location of permitted signs.

407.9 Screening:

See Section 515 of this Resolution for screening regulations for uses adjoining residential districts.

407.10 Maximum Percentage of Lot Coverage

25%

407.11 Minimum Lot Size

20,000 Sq. Ft.

407.12 Minimum Lot Frontage

200 Feet

SECTION 408 - B- 3 - HIGHWAY BUSINESS DISTRICT

(Subject to Section 412 Flood Overlay and Section 413 Well Field Overlay)

408.1 Intent and Purpose

This district is designed to provide for highway oriented uses and less intensive business types to serve the market of the urban area rather than the neighborhood and is typically mapped along major traffic arteries. The district regulations are designed to provide for properly located major shopping complexes which will be serviced with conveniently located off-street parking areas and safe pedestrian movement. Land to be placed in this district is intended to have level topography for safe ingress, egress and parking, public utilities, central water supply, offsite waste water disposal and major transportation facilities readily available. A Highway Business District should be not less than five (5) acres. Zoning of tracts smaller than this is discouraged. It is strongly recommended that such development be Planned Unit Development per Section 414.

408.2 Permitted Principal Uses

1. Public and semi-public buildings such as or similar to:
 - a. Churches;
 - b. Fraternal organizations;
 - c. Library;
 - d. Municipal offices;
 - e. Community Center
2. Automobile service stations including light repairs accessory sales and installations; also bicycle repair;
3. Automobile sales and service (new or used), truck and recreational vehicles, boat sales;
4. Auto wash facilities which are at least partially enclosed in a building;
5. Bars and refreshment stands;
6. Building services and supplies, including lumber yard;
7. Carry-outs;
8. Drive-in service establishments as referred to in Section 521;
9. Farm implement sales;
10. Fruit, florist, nursery stock and produce sales;
11. Furniture and appliances, including rugs, floor coverings, draperies, sewing machine shops, used furniture, office equipment, supplies and similar uses;
12. Gift shops, camera shops, record shops, book and stationery stores, jewelry stores, and similar uses;
13. Hardware and related stores as paint, wallpaper and similar uses;
14. Household appliance repair;
15. Mortuary establishments (a caretaker's residence may be provided within the main building of mortuary establishment);
16. Motels and hotels;
17. Open air commercial amusements;
18. Parking garage;
19. Photographic studios;
20. Plumbing and heating shops;
21. Professional and other offices drawing a large number of clients and/or customers such as, but not restricted to:
 - a. Chamber of Commerce and automobile clubs;

- b. Doctors, Dentists, Lawyers, Architects;
 - c. Insurance, Realtors, Unions;
 - d. Post office;
 - e. Utility office.
22. Publishing and printing;
 23. Repair shops such as shoe and watch repair;
 24. Restaurants;
 25. Service shops such as barber, beauty, laundry, cleaner and similar uses including laundry pick-up service and coin operated washing and dry-cleaning facilities;
 26. Travel agencies;
 27. Utility trailer sales and rentals;
 28. Variety stores.

408.3 Accessory Uses

Refer to Article II, Section 201 Accessory Use or Building: Is a use or building on the same lot with, and of a nature customarily incidental and subordinate to, those of the main use or building.

408.4 Conditional Uses

The following uses are allowed in any B-3 Highway Business District provided a conditional use is granted by the Board of Appeals as provided in Section 608 of this Resolution:

1. Any use of like nature of the permitted use in Districts B-1 and B-2 Business Districts.
2. Store & Lock /Mini-warehouse Facility provided the development meets the following requirements:
 - a. No activities other than rental of storage units and pick-up and deposit of storage shall be allowed on the store & lock facility premises. Examples of prohibited activities include but are not limited to the following:
 - (1) Auctions, commercial, wholesale or retail sales or miscellaneous or garage sales.
 - (2) The servicing, repair or fabrication of motor vehicles, boats, trailers, lawn mowers, appliances or other similar equipment.
 - (3) The operation of power tools, spray painting equipment, table saws, lathes, compressors, welding equipment, kilns or other similar equipment.
 - (4) Hazardous, explosives, radioactive, flammable: The storage of hazardous, explosive, radioactive and/or flammable materials as defined in the Fire Code, which could endanger the health, safety and welfare of Township residents shall not be allowed on the premises.
 - b. Outside Storage: Storage of goods and materials shall be confined in individual locker/stalls.
3. Scrap Tire Collection Facility

The Board of Zoning Appeals may consider a conditional Use if all of the following conditions are met:

 - a. The site has been approved by the Ohio EPA as a Class II Scrap Tire Storage Facility;
 - b. The site meets conditions for approval of the licensing authority for such a facility;
 - c. Tires are collected in a covered dumpster only;
 - d. Maximum one dumpster per site;

- e. Applicant provides a copy of the annual inspection report from the licensing authority for such a facility to the Township.

These conditions are in addition to those that may be required by the Board of Zoning Appeals.

4. Public garages, motor vehicle auto paint and body shops;
5. Agritourism

408.5 Yard Requirements

In a B-3 Highway Business District the following yard area shall be provided:

1. Front Yards: A 25-foot front yard shall be required excepting where the frontage on one side of the block is divided between B-3 Highway Business District and a Residential District, the Residential District setback shall apply.
2. Side Yards: Side yards shall not be required except a yard of not less than 10 feet in width shall be provided where a side lot line of the B-3 Highway Business District abuts a Residential District.
3. Rear Yards: Rear yards shall not be required except where a rear lot line of the B-3 Highway Business District abuts a residential district a rear yard of 30 feet shall be provided.

408.6 Building Height Regulations

No building in the B-3 Highway Business District shall exceed 2 1/2 stories or thirty-five (35) feet in height.

408.7 Accessory Parking

Space shall be provided in accordance with the provisions of Section 514.

408.8 Off-Street Loading

Spaces shall be provided in accordance with the provisions of Section 513.

408.9 Signs

See Section 517 for size and location of permitted signs.

408.10 Screening

See Section 515 for screening regulations for uses adjoining Residential Districts.

408.11 Maximum Percentage of Lot Coverage

20%

408.12 Minimum Lot Size

5 Acres

SECTION 409 - M-1 RESTRICTED OR LIGHT INDUSTRIAL DISTRICT:

(Subject to 412 Flood Plain Overlay and Section 413 Well Field Overlay)

409.1 Intent and Purpose

The purpose of the Restricted or Light Industrial District is to provide space for those industrial uses which operate in a clean and quiet manner and generate only light to moderate amounts of traffic. This district is not intended for the use of industries which deal with hazardous elements or emit noise, glare, dust, odor, smoke, or possess other offensive characteristics detrimental to surrounding land uses such as large traffic generation. The intent is to create and protect efficient light industrial areas by insuring careful design, placement, and grouping of industries which will promote the protection of any adjacent residential or business activities. Land to be placed in this district is intended to have level topography, public utilities, and major transportation facilities readily available. An Industrial District should contain at least fifty (50) acres adjacent to a major transportation corridor, with zoning of smaller tracts strongly discouraged unless factual information is presented that the proposed industry is consistent with maintaining rural character of the Township. It is strongly recommended that such development be Planned Unit Development per Section 414.

409.2 Permitted Principal Uses

1. Assembly plants which do not involve the use of hazardous material or create large amounts of waste materials or hazardous materials, i.e., electronic assembly;
2. Automobile repair, but no commercial wrecking, dismantling or salvage yard;
3. Auto service station;
4. Automobile, truck sales;
5. Bottling works;
6. Builders' supply store;
7. Building and trades, including contractor's yard and utilities storage yard;
8. Carpet cleaning, dry cleaning and dyeing, laundry;
9. Cold storage plant;
10. Commercial greenhouse;
11. Dairy products manufacture;
12. Fabrications, processing, packaging and/or manufacture of food products and condiments excluding fish products, slaughter houses and rendering and refining of fats, oils, fish, vinegar, yeast and sauerkraut;
13. Fabrication, processing, packaging and/or manufacture of cosmetics, drugs, perfumes, pharmaceuticals, and toiletries;
14. Fabrication, processing, packaging and/or manufacture of ice, cold storage plant, bottling plant;
15. Farm implements and contractor equipment sales and service;
16. Foundry casting light weight non-ferrous metals, or electric foundry, not causing noxious fumes or odors;
17. Furniture reupholstering and repair;
18. Industrial research laboratories;
19. Machine shops;
20. Monument sales including incidental mechanical operations;
21. Painting, varnishing shops;
22. Plumbing supply and contracting shops including storage yards;
23. Public garages, motor vehicle auto paint and body shops;
24. Repair, rental and servicing for appliances and equipment;

25. Sign contractor;
26. Storage yard for building supplies and equipment, contractor's equipment, food, fabrics, hardware and similar goods when located entirely within a building, provided such buildings shall not be used for wrecking or dismantling of motor vehicles;
27. Tool and die shop, wrought iron shop, blacksmith or machine shop, and punch presses;
28. Trailer rental and sales;
29. Veterinary clinic, animal hospital, provided that all animals are housed in buildings or enclosures which are at least two hundred (200) feet from any "R" District.;
30. Warehouses;
31. Wholesale distributors.

409.3 Accessory Uses

Refer to Section 201.

409.4 Conditional Uses

The following uses are allowed in any M-1 Restricted or Light Industrial District provided a conditional use is granted by the Board of Appeals as provided in Section 600.8 of this Resolution:

1. Planned Development (See Article IV, Sec. 414).
2. Agritourism

409.5 Yard Requirements

In an Industrial District the following yards shall be required:

1. Front yards shall not be less than twenty-five (25) feet in depth, excepting where an Industrial District is adjacent or across the street from any Residential District, the required front yard shall be not less than fifty (50) feet.
2. Side yards shall be not less than 15 feet in width on each side except where the side yard abuts a Residential District; it shall be not less than 100 feet. Any portion of a side yard which is in excess of 15 feet from a side property line may be used for parking.
3. Rear yards shall be not less than 15 feet in depth except where the rear yard abuts an alley, it shall be less than 30 feet or where the rear yard abuts a Residential District, it shall be not less than 100 feet.

409.6 Building Height Regulations

In this District, no building shall exceed three stories or 45 feet in height.

409.7 Accessory Parking

In an Industrial District, parking shall be provided as required in Section 514.

409.8 Off-Street Parking

Space shall be provided in accordance with the provisions of Section 514.

409.9 Signs

See Section 517.4 for size and location of permitted signs.

409.10 Screening

See Section 515 for screening regulations for uses adjoining Residential District.

409.11 Maximum Percentage of Lot Coverage

25%

409.12 Minimum Lot Size

50.00 Acres

409.13 Minimum Lot Frontage

200 Feet

SECTION 410 - M-2 HEAVY INDUSTRIAL DISTRICT

(Subject to 412 Flood Plain Overlay and Section 413 Well Field Overlay)

410.1 Intent and Purpose

The purpose of the Heavy Industrial District is to create and protect areas for industries which require large sites and should be isolated from other land uses by virtue of their external effects such as heavy traffic generation, open storage materials, and possible emission of noise, glare, dust, odor, smoke, or other offensive characteristics. This district is intended to insure proper design, placement, and grouping of all types of industries of this nature within the Township so as not to create a nuisance to other surrounding land uses. Land to be placed in this district is intended to have level topography, sufficient public utilities, and major transportation facilities readily available. An Industrial District should contain at least fifty (50) acres adjacent to a major transportation corridor, with zoning of smaller tracts strongly discouraged. It is strongly recommended that such development be Planned Unit Development per Section 414.

410.2 Permitted Principal Uses

1. Assembly plants such as automotive, tractor, trailer, farm implement assembly or manufacture, except automobile assembly plants or plants of similar nature, limited to 100,000 square feet of floor space;
2. Automobile wash facilities;
3. Automobile repair services and service stations;
4. Bakeries (wholesale);
5. Bleaching cleaning and dyeing plant;
6. Boat and marine equipment sales, rental and repair;
7. Boiler shops, structural steel fabricating shops, metal working shops;
8. Bottling works;
9. Builders supply stores;
10. Canvas, tent and awning sales and service;
11. Carpet and rug cleaning plants;
12. Cement products manufactured, including ready mix concrete batch plants;
13. Cold storage plants;
14. Commercial greenhouse;
15. Contractor sales, storage and equipment yards service;
16. Contract Construction Services (General);
17. Crematory service;
18. Dairy products manufacture;
19. Dental laboratory services;
20. Dextrine, starch or glucose processing;
21. Dry cleaning & dyeing;
22. Electric power manufacture;
23. Emery cloth or sand paper manufacture;
24. Enameling, lacquering or japanning;
25. Fabrication, processing, packaging and/or manufacture of articles or merchandise from the following previously prepared materials: bone, canvas, cellophane, cloth, cork, feathers, felt, fiber, horn, leather, paint, paper, plastics, precious or semi-precious metals or stones, textiles, tobacco, wax, wood and yarn;
26. Industrial research laboratories;
27. Laundries, dry cleaning and linen supply;

28. Lumber and other building materials (retail);
29. Machine shops and tool and die shops;
30. Machinery and heavy equipment sales and storage;
31. Manufacture, sale and storage of building materials excluding cement products;
32. Manufacturing, assembling or repairing of electrical and electrical products, components and equipment;
33. Mail order houses;
34. Mobile home sales, rental and repair;
35. Motels, hotels and tourist courts;
36. Monument sales including incidental mechanical operations;
37. Moving and storage company;
38. Music, musical instrument stores (retail);
39. Painting, varnishing shops;
40. Plumbing supply and contracting shops including storage yards;
41. Poultry killing and dressing;
42. Printing services;
43. Public garages, motor vehicle and bicycle repair shops, auto repair and body shop;
44. Railroad freight stations, but not including switching, storage, freight yards, maintenance or refueling facilities;
45. Railroad freight stations including switching storage, freight yards, maintenance or refueling facilities;
46. Recycling center - collection point only (outside storage);
47. Repair, rental and servicing for appliances and equipment;
48. Research and engineering laboratories;
49. Restaurants (drive-in);
50. Roller skating rinks;
51. Sales office and service centers;
52. Sawing and planing mills;
53. Sign painting and manufacturing;
54. Stone grinding, dressing, cutting;
55. Storage yards for building supplies and equipment, contractor's equipment, food, fabrics, hardware and similar goods when located entirely within a building provided, such buildings shall not be used for wrecking or dismantling or motor vehicles;
56. Tin and sheet metal shops;
57. Tool and die shop, wrought iron shop, blacksmith or machine shop;
58. Trailer and mobile home rental, sales and storage;
59. Truck terminal;
60. Warehouses;
61. Well drilling services;
62. Wire or rod drawing, nut, screw or bolt manufacture;
63. Wholesale sales and distribution.

410.3 Accessory Uses

(Refer to Article II, Section 201.)

410.4 Conditional Uses

The following uses are allowed in any M-2 Heavy Industrial District provided a conditional use is granted by the Board of Appeals as provided in Section 608 of this Resolution:

1. Automotive wrecking, junk or salvage yard, if in a completely enclosed building, or the premises on which such use is conducted is entirely enclosed within a solid fence or masonry wall not less than six (6) feet in height;
2. Cement products manufacture, including ready mix concrete batch plants;
3. Solid waste reduction and/or recycling facilities;
4. Storage facilities for fuel, coal, chemicals, or other flammable or toxic materials;
5. Manufacture and storage of fertilizer and compost;
6. Manufacturing or industrial enterprises, operations, or processes similar to any permitted principal use provided that any resulting cinders, dust, flashing, fumes, gas, noise, odor, refuse matter, smoke, vapor, or vibration shall not be greater or more detrimental to the neighborhood than the above specified uses and that no extra fire hazards be created.
7. Agritourism

410.5 Yard Requirements

In an Industrial District the following yards shall be required:

1. Front yards shall not be less than twenty-five (25) feet in depth, excepting where an Industrial District is adjacent or across the street from any residential district, the required front yard shall be not less than fifty (50) feet.
2. Side Yards shall be not less than 15 feet in width on each side except where the side yard abuts a residential district it shall be not less than 100 feet. Any portion of a side yard which is in excess of 15 feet from a side property line may be used for parking.
3. Rear Yards shall be not less than 15 feet in depth except where the rear yard abuts an alley, it shall be less than 30 feet or where the rear yard abuts a residential district, it shall be not less than 100 feet.

410.6 Building Height Regulations

In this District, no building shall exceed three stories or 45 feet in height.

410.7 Accessory Parking

In an Industrial District, parking shall be provided as required in Section 514.

410.8 Off-Street Parking

Space shall be provided in accordance with the provisions of Section 514.

410.9 Signs

See Section 517.04 for size and location of permitted signs.

410.10 Screening

See Section 515 for screening regulations for uses adjoining Residential Districts.

410.11 Maximum Percentage of Lot Coverage

35%

410.12 Minimum Lot Size

50 Acres

410.13 Minimum Lot Frontage

200 Feet

SECTION 411 M3 - MINERAL EXTRACTION AND STORAGE

(Subject to 412 Flood Plain Overlay and Section 413 Well Field Overlay)

411.1 Intent and Purpose

The purpose of this Section is to ensure that the mineral resources of Xenia Township are properly managed, and that the land is used with a minimum of environmental degradation, screened and reclaimed so as not to create a hazard or nuisance which may adversely affect the public health, safety, morals or general welfare of the community, either immediately or in the future and will conform to the standards, objectives, and policies of the current land use plan as adopted by the Xenia Township Trustees. The intent is to create a progressive plan for concurrent mining and reclamation which restores the land to its original or agreed upon use. Quarries, sand and gravel operations, or other mineral extraction operations will be permitted within the M-3 district. Associated industries which utilize the products of these operations shall be subject to approval as Conditional Uses by the Board of Zoning Appeals as described in Section 411.5.

Applications will be reviewed by Greene County Regional Planning. Public hearings shall be held by the Xenia Township Zoning Commission and the Xenia Township Trustees for review of all mining permits and proposed reclamation plans. These hearings shall be advertised by the placing of signs by the Township on the land with frontage on the roadway. This zoning district is only created through a map amendment. Therefore, additional restrictions in accordance with Article VII, Amendments, of the Xenia Township Zoning Resolution shall apply.

Permitted uses:

Mineral Extraction Operations

Drive-In Theater

Facilities for Adult Businesses as defined in Section 527

Outdoor Amphitheater

Outdoor Recreation and Parks

The following standards shall be guaranteed by the applicant:

411.2 Application for Map Amendment

All applications for the M-3 within Xenia Township shall be accompanied by the following information, at a minimum:

1. General Information
 - a. Name and address of the applicant, including all partners, officers, owners and/or operators of the corporation
 - b. Name and address of the owner of the property
 - c. Name and address of the owner of the surface rights of the property
 - d. A list of the types of resources or minerals to be extracted
 - e. The proposed method of removal of resources
 - f. A general description of the equipment to be used for excavating, processing, and/or transporting excavated mineral resources
 - g. A transportation plan for the site illustrating any proposed temporary operational roads, external routes and access points to the site
 - h. Hours of operation, subject to approval by the Board of Trustees in the interest of the health and safety of surrounding residents and businesses.
2. Schedule
 - a. A proposed schedule for the initiation and progression of mining on the property.

- b. Estimate the location, description and size of the area to be disturbed in the first year, and subsequent years, hereinafter called the footprint.
3. Maps
- a. Vicinity maps, drawn at a scale of one (1) inch equal to one thousand (1,000) feet illustrating
 - (1) the site in relation to surrounding existing and proposed land uses;
 - (2) existing and proposed roads;
 - (3) surrounding zoning districts;
 - (4) relation to land use plan currently adopted by Xenia Township;
 - (5) an aerial photo of the vicinity from a publicly available source shall be included.
 - b. Contour maps at a scale of at least one (1) inch equals two hundred (200) feet illustrating:
 - (1) existing contours at intervals of five (5) feet or less;
 - (2) any existing structures;
 - (3) any public utilities or easements on the property.
 - c. Surface water map - flow rates and direction
4. Screening Plan Quarry Depth Adjacent to Road
- Whenever the floor of a quarry is greater than five (5) feet below the average elevation of an adjacent public street or any adjacent property, the property containing such quarry shall be completely enclosed by an earth mound not less than six (6) feet in height or higher as needed to provide a visual and noise barrier, and planted with suitable landscaping, and/or fence not less than six (6) feet in height. An earth mound that requires mowing shall have a slope no greater than 3:1. All plantings or fences shall be sufficient, in either case, to potentially deter persons from trespassing upon the property and shall be properly maintained by the owner/operator. Such mound shall be located not less than twenty-five feet from any street right-of-way or boundary of the quarry property. Such barriers may be excluded where deemed unnecessary by the Board of Trustees because of the presence of a lake, stream, or other existing natural barrier.
5. Studies
- Studies to be conducted by a qualified professional engineer registered in the State of Ohio or other expert in the field as approved by the Board of Trustees, at the applicant's cost:
- a. Study of excavations and existing water table:
 - (1) anticipated depth of excavation
 - (2) effect to water table
 - (3) data on wells in the area
 - (4) existing ground water conditions at the site
 - (5) demonstrate that the source of any public or private water supply shall not be adversely affected due to the lowering of the water table or contamination of the supply
 - b. Hydrologic study:
 - (1) determine and describe surface water in the vicinity
 - (2) map of surface water (same as 3.c Maps above)
 - (3) information relating to flow rates and direction

6. Proposed Structures

The proposed location of any processing plant and related structures to be used and any accessory or kindred operations that may be utilized in connection with the operation of a processing plant by the mining processor or any other firm, person, or corporation; buildings and structures, storage facilities, plantings and fences if necessary, all subject to Board of Appeals approval of a Conditional Use (see Section 411.5) after rezoning is approved and state permit is issued.

7. Reclamation Plan

A plan for the reclamation and restoration of the site as specified in this Section. The reclamation plan for the site shall be reviewed for compliance at the end of each twelve (12) month period by the Xenia Township Trustees or their designated representative. Reclamation shall be in compliance with the intent of the reclamation plan. Operator shall provide a copy of ODNR annual approved permit. The reclamation plan for the site shall contain, at a minimum, the following information and meet the following requirements:

- a. A map at a scale of at least one (1) inch equals two (200) hundred feet showing future contours at intervals of five (5) feet or less, any proposed structures, and any public utilities or easements on the property;
- b. The depth and type of the proposed cover shall be sufficient to meet the proposed intended use;
- c. The material used in reclamation shall be identified;
- d. The angle of slope of all earthen banks shall be no greater than one (1) foot vertical to three (3) feet horizontal. In areas where at the commencement of excavation a greater angle existed, the angle of slope shall be no greater than that which existed at the commencement of excavation;
- e. The angle of slope of all banks consisting of rock and the required cover;
- f. The location of fences or effective plantings in those locations where the Board of Trustees determines that such angles of slope are not physically or economically feasible to reduce;
- g. The number of trees and shrubs, and the type of ground cover to be provided: The type and number per acre of trees, shrubs, ground cover or legume to plant shall be determined in consultation with the Greene County Agricultural Extension Agent;
- h. The location of proposed ultimate land uses and physical improvements such as roads, drives, drainage courses, utilities and other improvements as determined in consultation with the Regional Planning and Coordinating Commission, the County Engineer, and the Sanitary Engineer;
- i. A statement that vegetation shall be restored by the spreading of sufficient soil and by appropriate seeding of grasses or planting of shrubs and trees in all parts of said reclamation area where the same is not submerged under water.

8. Demonstration of Compliance

The applicant shall demonstrate compliance with all previously issued permits.

9. Any other information the reviewing board(s) may deem necessary in order to determine that the proposed extraction operation will not be detrimental to surrounding land uses and the community in general.

411.3 Mining Permits and Proposed Reclamation Bonds

1. The application will be processed in accordance with Article VII - Amendments. If the request to rezone is approved by the Xenia Township Trustees, the applicant is required to provide a copy of the permit from Department of Natural Resources, and proof of performance and closure bonds described herein. If all other requirements have been met, the applicant will be granted an annual operating permit from the Xenia Township Zoning Inspector.
2. Permit - Department of Natural Resources
All proposed mineral extraction operators shall be required to secure a permit for such activities from the Chief of the Department of Mineral Resource Management, Ohio Department of Natural Resources. Where possible, the operator will complete the state permit application using the same specifications as approved by the Board of Township Trustees in the rezoning process.
3. Performance and Closure Bond
 - a. To guarantee that ongoing operations and future closure are in accordance with the conditions and standards established at the time of approval, a mining and closure plan and a mining and closure bond shall be furnished to the Clerk of Xenia Township, Greene County, Ohio. The applicant shall also post a performance bond or a reasonable equivalent as determined by the Trustees to ensure adherence to all requirements of Section 411. The amount of the bonds shall be set by the Xenia Township Trustees and be based upon an estimate of costs to meet the aforementioned requirements, prepared by a professional engineer, registered in the state of Ohio and submitted by the applicant. The amount of the bonds shall be sufficient to offset damages in the event of violations of specified requirements and conditions of operations and sufficient to complete reclamation as necessary. The Township reserves the right to periodically review and increase the amount of the performance and closure bond based upon new information, changed conditions, circumstances, or inflationary factors.
 - b. To guarantee the restoration, and reclamation of mined-out areas within a reasonable time, every applicant approved to conduct a mineral extraction operation, as herein provided, shall complete reclamation and restoration per the agreed upon reclamation plan. Reclaiming and restoring the land shall include but not be limited to removal of unwanted structures, equipment, asphalt operations belonging to the operator, disposal of tanks and cleanup of maintenance and support areas. Upon completion of quarry operations, the applicant/operator shall submit a restoration report prepared by a registered Ohio Professional Engineer, certifying that the restoration plan has been fully completed as required. This shall be submitted to the Zoning Enforcement Officer for compliance review and transmittal to the Board of Trustees. If restoration and reclamation is deemed completed the bond shall be released.

411.4 Environmental Issues

1. Noise Restrictions
 - a. Decibel Measurement Criteria:
Any decibel measurement made pursuant to the provisions of this chapter shall be as measured with a sound level meter using "A" weighting.
 - b. Land Use Area Noise Control:

Definitions of land use classes for noise control purposes, in this section, the use of the land to which noise is emitted determines when such noise is in violation of this section. Different levels of noise are permitted according to the land use categories listed below. The land use classes are defined according to the zoning districts outlined in the zoning resolution.

- (1) CLASS 1 includes all land classified under residential, group housing projects and planned unit development districts, as defined in this zoning resolution as E, Rural Residential Estate, R-1 Single Family Residential, RM - Multi-Family Residential, PUD –R, planned unit development, R-MH, Mobile Home Park.
- (2) CLASS 2 includes all land classified under zoning districts A-agriculture, F-1 Flood Plain, IG - Institutional Governmental, B-1, Convenience Shopping District, B-2 Neighborhood Business, B-3, Highway Business
- (3) CLASS 3 includes all land classified under zoning districts, M-1, Light Industrial district or M-2 Heavy Industrial.

c. Establishment of Noise as a Pollution

It is unlawful for any person to create any noise, which would cause the noise level at the property line of any property to be more than five (5) decibels above the established standard as outlined below in Sections a, b and c, for a cumulative period of fifteen (15) minutes in any hour. At the property line between two classes/districts the most restrictive standard shall be used.

- (1) Noise emitted to Class 1. When measured at a height above the ground of four feet or more, and at the property line of areas designated Class 1, noise possessing one or more of the characteristics listed below shall be considered in violation of this resolution:
 - (a) During the hours of 7:00 a.m. to 10:00 p.m.:
 - (i) Continuous sound in air which has a sound level in excess of sixty-five (65) decibels on a “a” weighted scale, slow response, on a sound level meter: or
 - (ii) Impulsive sound in air which has a true peak sound pressure level in excess of one hundred twenty (120) decibels.
 - (b) During the hours of 10:00 p.m. to 7a.m.:
 - (i) Continuous sound in air which has a sound level in excess of fifty-five (55) decibels on the “a” weighted scale, slow response, on a sound level meter: or
 - (ii) Impulsive sound in air which has a peak sound pressure level in excess of eighty (80) decibels.
- (2) Noise emitted to Class 2. When measured at a height above the ground of four feet or more, and at the property line of areas designated Class 2, noise possessing one or more of the characteristics listed below shall be considered in violation of this resolution at all times:
 - (a) Continuous sound in air which has a sound level in excess of sixty-five (65) decibels on the “a” weighted scale, slow response, on a sound level meter; or

- (b) Impulsive sound in air which has a peak sound pressure level in excess of one hundred twenty (120) decibels.
 - (3) Noise emitted to Class 3. When measured at a height above the ground of four feet or more, and at the property line of areas designated Class 3, noise possessing one or more of the characteristics listed below shall be considered in violation of this resolution at all times:
 - (a) Continuous sound in air which has a sound level in excess of seventy-five (75) decibels on the “a” weighted scale, slow response, on a sound level meter; or
 - (b) Impulsive sound in air which has a true peak sound pressure level in excess of one hundred twenty (120) decibels.
 - (4) Exclusions. The following sounds shall not be considered noise: Sounds generated within the environs subject to the provisions of the labor and safety laws, such as sounds emitted by safety devices, providing the sound does not exceed the minimum levels set by the regulatory agency; and sounds incidental to construction of barriers required under this Section 411.
- 2. Dust

All trucks will be prohibited from depositing foreign materials onto the public roadways. This shall include dust, rocks, sand, and clay. Trucks will be cleaned on site before using public roads.
- 3. Blasting

The operator shall maintain complete records on a daily basis of all blasting operations including records of the time, the date, the location, and complete description of weather conditions such as time, temperature, humidity, and wind velocity relating to each such blast. Such records shall be available to the Zoning Inspector upon request.
- 4. Public Roadway Restrictions

At no time shall an emergency vehicle be restricted from access to a public road for any reason including but not limited to: on road parking, deliveries, business operations, moving of equipment, etc.
- 5. Gas Pipeline Safety

Residents, schools and businesses within 2500 feet of a blast shall be notified 24 hours in advance of a planned blast when the blast is within 500 feet of a high-pressure gas pipeline. If possible, the operator will provide a blasting schedule to the Township.

411.5 Conditional Uses

The Xenia Township Board of Zoning Appeals shall have the authority to hear and decide the following conditional uses as outlined in Section 600.8.4 of this resolution. At the request of the Board of Zoning Appeals, the operator shall fully cooperate in any investigation by the Board of Zoning Appeals of the conditions of the operation. Prior to the submission of an application for a conditional use certificate, an applicant, in accordance with Division (b) of Section 303.141 of the Ohio Revised Code, shall send written notice to the County Engineer of the applicant’s intent to apply for a conditional zoning certificate. The County Engineer and Board of County Commissioners shall proceed in accordance with Divisions (B) (1) to (3) of Section 303.141 of the Ohio Revised Code. As provided in Division (b)(3) of that Section, the applicant or an affected Board of Township Trustees may submit written notice

of appeal regarding a decision of the Board of County Commissioners under Division (b) (2) of that Section.

1. Storage and Processing
The location of any storage or processing activities upon the site will be subject to approval by the Board of Zoning Appeals because of possible detrimental external effects such as air or water contamination. All such activities shall be naturally or artificially screened from any public street, existing dwelling unit, or any residentially zoned property. Storage does not include materials extracted from the site.
2. Buildings
Buildings and structures designed and constructed exclusively for mineral extraction, storage, or processing, for which no future use is contemplated and no other use is practical or feasible, shall be demolished and removed in accordance with the reclamation plan.
3. Associated Industries
Associated industries which utilize the products of mineral extraction operations, or other related mineral extraction operations may be permitted within this specified district upon submission of satisfactory proof that such operations will not be detrimental to the neighborhood or surrounding properties.
4. Inspections of nearby structures and water wells to determine structural integrity and water levels;
5. Ensure compliance with applicable federal, state, and local laws and regulations;
6. Identification of specific roads in accordance with Division (b) of Section 303.141 of the Ohio Revised Code to be used as the primary means of ingress to and egress from the proposed activity;
7. Ensure compliance with reasonable noise abatement measures, (as defined in Section 411.4.1);
8. Ensure compliance with reasonable dust abatement measures, (as defined in Section 411.4.2);
9. Establishment of setbacks, (as defined in General Provisions of Section 411.6, and berms and buffers for the proposed activity (as defined in Screening of Section 411.2.4);
10. Establish a complaint procedure;
11. Establishment of any other measure reasonably related to public health and safety. When granting a conditional use certificate, the Board of Zoning Appeals shall not require the identification of specific roads, as otherwise authorized in Division (A)(3) of Section 303.141 of the Ohio Revised Code, and the identification of specific roads in accordance with Division (B) of that Section shall not apply for any of the following:
 - a. The transfer of unfinished aggregate material between facilities that are under the control of the same owner or operator;
 - b. The loading or unloading of finished aggregate product within a ten-mile radius of a surface mining operation;
 - c. The expansion of an existing surface mining operation when the specific road that is used as the primary means of ingress to and egress from the operation will be the same road that is used for that purpose after the expansion of the facility.

The identification of specific roads in accordance with this section and Division (b) of Section 303.141 of the Ohio Revised Code to be used as the primary means of ingress to and egress from a proposed activity becomes effective only upon the granting of a conditional zoning certificate by the Board of Zoning Appeals.

411.6 General Provisions

1. Depth

Mineral extraction to a depth not exceeding six (6) feet may be conducted up to one hundred (100) feet of any residential district, provided the operation is conducted over a temporary period not to exceed twelve (12) months, and the operation of equipment is limited to the extraction process. Further, mineral extraction to a depth exceeding six (6) feet may be conducted up to two hundred and fifty (250) feet of any residential district or existing dwelling, providing the operation does not use explosives and the operation of equipment is limited to the extraction process. All other mineral operations shall not be conducted closer than five hundred (500) feet from an existing Residential District or existing dwelling.

2. Temporary Roads

Temporary operational roads shall not be located closer than four hundred (400) feet from any Residential District or any existing dwelling. All trucks leaving the location of operations shall use paved or improved roads only.

3. Lateral Support - Public Road

In order to ensure adequate lateral support for public roads in the vicinity of mineral extraction operations:

- a. All excavations shall be located at least 100 feet and back filled to at least 150 feet from a street right-of-way line.
- b. All quarrying or blasting shall be located at least 100 feet from any right-of-way.
- c. Such excavation or quarrying may be permitted within these limits to the point of reducing the ground elevation to the elevation of the existing or platted street, road, or highway centerline where officially approved by the authority charged with maintenance of such platted street, road, or highway.

4. Excavations - Depth or Grade

All excavations shall either be: (1) made to a depth not less than five feet below a water-producing level, or (2) graded and/or back filled with non-noxious and non-flammable solids, to assure that the excavated area will not collect and retain stagnant water. The graded or back filled surface shall create an adequate finished topography to minimize erosion by wind or rain and substantially conform with the contours of the surrounding area.

5. Banks

The underwater banks of all excavations which are not back filled shall be sloped at a grade of not less than 3-feet horizontal to 1-foot vertical a minimum six (6) feet below the water line. Spoil banks shall be graded to a level suiting the existing terrain and planted with trees, shrubs, legumes, or grasses where re-vegetation is possible.

6. Excavation Area – Lake

- a. When any quarrying has been completed, such excavated area shall either be left as a permanent lake, or the bottom floor thereof shall be leveled to prevent the collection and stagnation of water and to provide proper drainage without excessive soil erosion. Said floor shall be covered with soil, of adequate

thickness for the growing of turf or other ground cover as required by Xenia Township.

- b. If such quarried area is left as a permanent lake, all sides must be sloped to no greater than one (1) foot vertical to three (3) feet horizontal extending to a six (6) foot depth, or a stable bank be established.

411.7 Annual Operating Permit

Operator shall obtain annually an operating permit which certifies conformance to all requirements of Section 411. For good cause shown, the Xenia Township Trustees may impose such other reasonable conditions and restrictions as may be necessary for protection of public health, safety, morals and general welfare during this mining and restoration process.

Operator shall submit the following information to obtain the permit:

1. Proof of current bonds (certified annually that bond is in place)
2. Copy of annually approved state permit
3. Mining maps indicating the proposed mining and reclamation plan for the next 12 months may be requested.

411.8 Enforcement

1. The Xenia Township Zoning Inspector or designated substitute shall be granted access to the permitted land for on-site inspection after a twenty-four (24) hour notice has been given to the operator. Any facility that fails to demonstrate compliance or fails to conform to the requirements and limitations contained in the permit may have its general permit suspended or revoked.
2. The Zoning Inspector or designee shall visit the site at any time if cause for a violation to the conditions exists.
3. No materials may be used for reclamation which are hazardous or have the potential to contaminate ground water or threaten the public health. Permission to use any material may be revoked upon written notification to the operator from the township zoning inspector.
4. In the event that it is established as a matter of fact that there has been a failure to adequately comply with the provisions of this Section, said operators shall take immediate steps to provide full compliance herewith. In the event the operator does not comply, the state authority issuing permits for mineral extraction shall be notified of the violation and nonconformance with local zoning regulations.
5. In the event the operator has been found responsible for the diminution, contamination, or interruption of a public or private water supply, the operator shall be responsible for costs of replacement of that water supply including drilling new wells or providing a connection and hook up to public water.

411.9 Minimum Lot Size

25 Acres

411.10 Minimum Lot Frontage

500 Feet

SECTION 412 - F-1 - FLOOD PLAIN OVERLAY

412.1 Intent and Purpose

The Flood Plain Overlay District shall be an overlay to the existing underlying district(s) as shown on the Official Zoning Map, and as such, the provisions for the Flood Plain Overlay District shall serve as a supplement to the underlying district provisions. This overlay is comprised of lands that are subject to periodic flooding. It is intended to preserve the existing "flood plains" so as to allow the waterways a place to overflow at high water levels and thus assist in protecting other areas not now subject to flooding.

412.2 Prohibited Uses

The following uses shall be expressly prohibited from locating within the Flood Plain Overlay District.

1. The location of structures or fill material in the floodway.
2. The location of structures or fill material, which will increase the level of the base flood elevation.

Xenia Township shall not incur any liability whatsoever by permitting certain uses within any flood plain overlay.

412.3 Conditions for Permitted, Accessory Uses Within the Floodway Fringe

Permitted and accessory uses shall be that of the underlying district. No permitted or accessory uses of the underlying district are permitted unless the use complies with the following:

1. The elevation of the floor of the first story of a fully or partially enclosed building shall be at a minimum of eighteen (18) inches above the base flood elevation.
2. Ingress and egress to the fully or partially enclosed building shall be above the base flood elevation.
3. Compensatory storage required for structure or fill material within the regulatory flood plain shall result in no net loss of natural flood plain storage. The volume of the loss of floodwater storage due to a structure or fill material within the regulatory flood plain area shall be offset by providing a hydraulically equivalent volume of flood storage by excavation or other compensatory measures in accordance with the following requirements:
 - a. Prior to the issuance of a zoning certificate/permit, a plan and calculations shall be prepared by a professional engineer and submitted for approval. This plan shall be based on a field survey, shall show the existing and proposed grades of the development with compensatory storage area(s) and shall be accompanied by calculations which demonstrate that the proposed storage versus storage volume relationship of the compensatory storage area would have the same or greater volume at each stage as in the pre-development condition of the proposed development area.
 - b. The compensatory storage area shall have a hydraulic connection to the affected watercourse which is equal to or greater than the pre-development condition and shall provide the same or improved rate of flood storage capture and discharge over the course of the flood event as in the pre-development condition.
 - c. Compensatory storage shall be located adjacent to the development area or in the opposite side of the water body across from the development area. In the case of filling for a new crossing, the compensatory storage shall be located upstream of the crossing.

- d. The compensatory storage area shall be a permanent component of the property and shall be repaired or replaced by the owner of the property if silted-in or otherwise compromised.
 - e. The design and creation of the development and compensatory storage areas shall incorporate best management practices to minimize soil erosion and sediment impacts (to be reviewed and approved by the Greene Soil and Water Conservation District).
4. After all construction requirements have been completed, an as-built topographic survey (stamped by a registered professional surveyor) of the development and compensatory storage area shall be submitted to the Township Zoning Inspector. This survey shall be accompanied by as-built stage versus storage volume calculations prepared by a registered professional engineer as required in Section 412.3(3)(a) above.
 5. After all construction requirements have been completed, the applicant shall be required to submit technical data and to obtain a Letter of Map Revision from FEMA.

412.4 Required Conditions for Underlying Conditional Uses

1. All applications for a Conditional Use Permit within the Flood Plain Overlay District shall comply with the items listed under Section 412.3.
2. Upon consideration of the application for a Conditional Use Permit, the Board of Zoning Appeals may attach conditions to such uses as it deems necessary to further the purposes of this Section. Such conditions may include but not be limited to modifications of waste disposal and water supply facilities to the satisfaction of the Greene County Combined Health District and/or the public water and wastewater collection purveyor.
3. For each application, the Board of Zoning Appeals shall consider the following relevant factors:
 - a. The danger of loss of life and/or property due to increased flood heights or velocities caused by encroachments.
 - b. The danger that materials may be swept on to other lands or downstream to the injury of others.
 - c. The proposed water supply and sanitation systems and the ability of these systems to prevent disease, contamination and unsanitary conditions.
 - d. The compatibility of the proposed use with existing development and Perspectives: A Future Land Use Plan for Greene County, Ohio.
 - e. The safety of access to the property in times of flood for ordinary and emergency vehicles.

Note: Any development activities in the regulatory flood plain are also required to meet the requirements of the Flood Damage Reduction Resolution, Greene County, Ohio (most current version) and the applicant shall obtain the appropriate approval/permit from the Greene County Flood Plain Administrator.

SECTION 413 – WP - WELL FIELD PROTECTION OVERLAY DISTRICT

413.1 Intent and Purpose

The intent of the Well Field Protection Overlay District is to safeguard the public health and safety by protecting the community water supplies within Xenia Township through the regulation of potentially polluting land uses and Regulated Substances (Regulated Substances are chemicals and mixtures of chemicals which are health hazards in groundwater. Materials packaged for personal or household use are not Regulated Substances.) (See Section 201.)

The provisions of this Section shall be applicable to community water supply systems within the Township that have currently maintained and scientifically delineated protection areas endorsed by the Ohio EPA and those community water supply systems in which the purveyor has requested this overlay district be applied for their system. The Well Field Protection Overlay District shall include all lands located within the community water supply system's "one-year capture area" as defined by the Ohio EPA. The provisions of the Well Field Protection Overlay District shall be supplemental to the regulations of the underlying zoning district and Flood Plain Overlay District. Where the requirements of this Section are in conflict with the regulations of the underlying district and the Flood Plain Overlay District, the more restrictive regulations shall apply.

The Well Field Protection Overlay District will be implemented in conjunction with the purveyors of the community water systems. The Township may require technical or financial assistance to fully implement portions of this overlay district and the purveyors will be required to provide this assistance for their systems. The Township Trustees and/or the Township Enforcement Officer will in all cases be the deciding authority in decisions regarding the Well Field Protection Overlay District.

Implementation

Successful implementation of the Well Field Overlay District will require property owners and those persons responsible for the storage, use, handling, or production of Regulated Substances to provide inventory and use information on Regulated Substances and evidence and/or documentation of applicable best management practices (BMP's) being utilized to manage the substances to the Township.

Upon application for a zoning certificate, appeal of a zoning certificate, or conditional use for properties within this overlay district, the Xenia Township Trustees may employ such technical expertise as needed to ensure compliance with the provisions of these regulations. All reasonable costs, with prior notice to applicant, incurred in the compliance review process shall be passed through to the applicant and shall be in addition to those fees normally charged to review the application for a zoning certificate.

A Business Occupancy Permit will be used to capture information necessary to comply with the intent of this overlay district. Any change in use or re-zoning of an existing commercial building, or construction of a structure for commercial use shall require completion of a Business Occupancy permit.

413.2 Permitted Uses

Within the Well Field Protection Overlay District, the permitted uses are defined in Article IV of the Xenia Township Zoning Resolution and shall be those of the underlying zoning district, unless prohibited within the Well Field Protection Overlay District

413.3 Conditional Uses

Within Well Field Protection District, the conditional uses shall be those of the underlying zoning district in addition to the requirements contained in this Section.

Any request for a zoning permit or change of zoning on a parcel or parcels within the Well Field Protection District that will involve Regulated Substances meeting the criteria set forth in Section 413.6, shall be subject to obtaining conditional use approval.

In addition to the conditional use procedure requirements set forth in Section 600.8.4, if a proposed activity/use will involve Regulated Substances meeting the criteria set forth in Section 413.6, the applicant shall provide the Township Zoning Enforcement Officer with a written plan that describes the proposed activity, lists the specific regulated substances and quantities involved, analyzes any potential threats posed by the activity to groundwater resources, and provides information on the Best Management Practices that will be utilized to reduce and/or alleviate those threats. This plan shall be used by the Zoning Commission and Board of Zoning Appeals to render a decision on the proposed conditional use.

413.4 Prohibited Uses

Any land use not specifically designated as permitted or conditional uses as provided in Article IV of this Zoning Resolution shall be prohibited.

413.5 Non-Conforming Uses

A use, property or business in operation at the time this overlay district was adopted and having an amount of regulated substances exceeding the quantities set forth in Section 413.6 A. is a non-conforming use and is allowed to remain; however, no change of occupancy (ownership or tenants) or any expansion involving regulated substances, or any modification resulting in an increased amount of regulated substances on the property is permitted without approval in accordance with these zoning regulations. A use, property or business must comply with all other sections of this District. If a non-conforming use of any land, building, or structure is discontinued for two (2) years or more, any further use shall be in conformity with this Well Field Protection Overlay District.

413.6 Groundwater Protection Standards (Quantity Limits)

1. Quantity Limitation. Use, storage, handling and/or production of Regulated Substances in conjunction with permitted, accessory, and conditional uses in this district shall be limited to aggregate of Regulated Substances. The aggregate of Regulated Substances in use, storage, handling and/or production may not exceed fifty-five (55) gallons or four hundred forty (440) pounds, whichever is less at any time.
2. Limited Exclusions. A limited exclusion from the provisions of Section 413.6.1 is authorized for the following types of Regulated Substances and quantities for purposes of reporting as outlined in 413.10, however, they are still Regulated Substances and are still subject to spill reporting requirements at outlined in Section 413.8.
 - a. Regulated Substances used for the non-routine maintenance and repair of property or equipment. The use, storage, handling and/or production of Regulated Substances under this exclusion shall be limited to:
 - (1) The aggregate of Regulated Substances in use, storage, handling, and/or production may not exceed fifty (50) gallons or four hundred (400) pounds at any time.
 - (2) The total use, storage, handling and/or production of Regulated Substances may not exceed one hundred (100) gallons or eight hundred (800) pounds, whichever is less, in any twelve (12) month period.

(3) The application of U.S.E.P.A. approved agricultural chemicals by licensed personnel using U.S.E.P.A. best recommended practices. Below ground applications in excess of hundred (100) gallons or eight hundred (800) pounds in any twelve (12) month period shall require seventy-two (72) hour prior notice to the Enforcement Officer.

- b. Medical and research laboratory substances in containers not to exceed five (5) gallons or forty (40) pounds of each substance.
- c. Cleaning agents, sodium hypochlorite as used for swimming pools, medicines, and cosmetics packaged for personal or household use.
- d. On-site storage of agricultural chemicals to be used for routine on-site agricultural operations, provided such substances are stored in standard approved packaging and such chemicals are applied to cropland under Best Management Practices as indicated by soil tests, agricultural experts, or label directions approved by the United States Environmental Protection Agency (EPA) or the Ohio Department of Agriculture. This limited exclusion also applies to the application of agricultural chemicals to cropland where such chemicals are brought in from other locations. This provision does not exempt such agricultural chemicals either stored on-site or brought in from other locations from the inventory, spill reporting and underground storage tank protection requirements of the Well Field Protection Overlay District.

NOTE: This regulation does not restrict the use of agricultural chemicals applied in accordance with best management practices and/or label directions.

- e. Transportation of regulated substances through the Well Field Protection Overlay District provided that the transporting vehicle is in compliance with applicable federal, state and local laws and regulations, and provided that the regulated substance is fueling the transporting vehicle or the transporting vehicle is in continuous transit, making delivery, or is stopped for a period of time not to exceed twenty-four (24) hours.
- f. Regulated substances that are within containers such as gas tanks, radiators, transmissions, brake lines and other similar containers that are an integral part of an operable motor vehicle or boat and used specifically and solely for the operation of the vehicle in which the substances are contained. Except as provided for in Section 413.6.2.e, the tanker portion of a tractor trailer shall not be included in this exclusion.
- g. Regulated substances associated with paving, the pouring of concrete, or construction for which all necessary permits have been obtained, provided such regulated substances are present at the construction site for which the permits have been issued and do not pose a real and present danger of contaminating surface and/or ground water.
- h. Refrigerants contained in equipment used for on-site air cooling or contained in household appliances.
- i. Cosmetics as defined by Section 321(I) (1) of Title 21 of the United States Code provided these products are prepackaged for personal or household use by the general public. The manufacture, extraction, warehousing, or repackaging of these products shall not be excluded.

- j. Heating fuels used solely for building heat provided such heating fuel is stored in standard approved tanks.
 - k. Animal maintenance and medicinal substances packaged for residential or agricultural purposes.
- 3. **Underground Storage Tanks.** All underground storage tanks shall be in accordance with the following provisions:
 - a. **Existing Tanks.** Owners and operators of underground storage tank systems which are located within the Well Field Protection Overlay District shall comply with the latest rules adopted by State of Ohio Bureau of Underground Storage Tank Regulations (BUSTR).
 - b. **New Tanks.** New underground storage tanks and/or replacement of existing underground tanks are not permitted.
- 4. **Containment Systems.** Drums and other types of containers holding Regulated Substances and wastes of such substances shall be stored within secondary containment. Secondary and tertiary containment systems, including the use of containment during chemical storage, transfer, and use. The containment system shall be designed to capture 110% of a release from a primary containment unit. Existing containment systems and procedures shall not be removed, nor shall their ability to contain spills be compromised, so long as Regulated Substances are stored, transferred or used within the containment areas. Improvements and/or additions to containment systems may be performed so long as the ability to contain a spill is not compromised. Temporary approved containment systems may be required during maintenance and/or improvement activities.
- 5. **Septic Systems.** Greene County Combined Health District (GCCHD) governs residential septic systems. All residential septic systems shall be permitted by the GCCHD and maintained by the owner in accordance with GCCHD regulations. Such systems shall be periodically pumped-out at the interval recommended by the GCCHD. Commercial septic systems are governed by the Ohio EPA. All commercial septic systems shall be permitted by Ohio EPA and be maintained in accordance with state law.
- 6. **Disposal of Septic Waste.** Disposal of septic waste is governed by the U.S. Code of Federal Regulations (40 CFR) Part 503. Disposal of such waste is prohibited.
- 7. **Wastewater Treatment Facilities.** Disposal of bio solids from waste-water treatment facilities is prohibited.
- 8. **Application of Agricultural Chemicals.** Agricultural chemicals shall be applied in accordance with best management practices and/or label directions.

413.7 Management of Regulated Substances

- 1. No person shall place, deposit, or permit to be deposited, store, process, use, produce, dispose of, transport, or discharge, hereinafter referred to as "handle," any regulated substance on public or private property within the Well Field Protection Overlay District, except as provided by law, statute, ordinance, rule or regulation.
- 2. With the exception of single or two-family residences wherein the regulated substances are for the maintenance of the residence or vehicles under control of the occupant, the use of any land, building, or structure in the Well Field Protection Overlay District in which any Regulated Substances are handled and for which an annual inspection has not been completed is hereby determined to be a dangerous public nuisance.

3. Any violation of Section 413.7.1 or 413.7.2 is hereby determined to be a nuisance and must be abated in accordance with the provisions in Title V ORC.

413.8 Spills, Leaks or Discharges

1. **Notification Required.** Any person with direct knowledge of a spill, leak or discharge of a Regulated Substance within the Well Field Protection Overlay District shall, if such spill, leak or discharge escapes containment or contacts a non-impervious ground surface and is not immediately and completely remediated, give notice to the Local Fire Department (911) and the operator on duty at the affected or potentially affected water treatment facility by telephone within thirty (30) minutes of the occurrence. The notification shall include at a minimum, the location of the incident, name and telephone number of person reporting the incident, date and time thereof, type of substance(s), concentration and volume, and control or corrective action taken. Such notification shall in no way alleviate other local, State, and Federal reporting obligations as required by law. When it is impractical for a person to give such notice within the first thirty (30) minutes, notice shall be given as soon as it becomes practical to do so, but not to exceed two hours.
2. **Application of Agricultural Chemicals.** The application of agricultural chemicals, fertilizers, mineral acids, organic sulfur compounds, etc. used in routine agricultural operations, including plant nutrients and crop protection materials, applied under Best Management Practices as indicated by soil tests, agricultural experts, or label directions approved by the United States EPA or the Ohio Department of Agriculture, shall not be considered a spill, leak, or discharge subject to the reporting provisions of this Section.
3. **Liability and Required Documentation.** Any entity or person who spills, leaks or discharges said substance(s) shall be liable for any expense, loss or damages incurred by Xenia Township or the public water supply operator in response to such an incident, in addition to the amount of any fines imposed on account thereof under State and Federal law. Said entity or person shall document and maintain sufficient records so as to reflect accurately the circumstances related to any such incident and develop and implement procedures to substantially eliminate the likelihood of reoccurrence of such spills, leaks or discharges as soon as practicable following the incident, but no later than one hundred eighty (180) days after the incident.

413.9 Clean Closure Requirements

Except in the case of a seasonal discontinuation of operation, the owner or operator of any non-residential property that becomes unoccupied or has discontinued operation for a period of ninety (90) consecutive days shall remove all regulated substances from the property, other than those used exclusively for heating, cooling, and providing electrical lighting for the premises, within ninety (90) days after the date upon which the property initially became unoccupied or the operation discontinued. Except as noted above, regulated substances, which are excluded from reporting requirements, shall be removed by the date specified above. The owner or operator shall secure the regulated substances on the property until they have been removed. The owner or operator shall notify the Xenia Township Enforcement Officer in writing of the date of the cessation of operation or the property becoming unoccupied no later than the day upon which the operation actually ceases or the property becomes unoccupied, and such notification shall include the owner's name, phone number, and address and the operator's name, phone number, and new address.

413.10 Regulated Substance Reporting

1. Owners and operators with applicable types and quantities of Regulated Substances shall, upon request of the Township Enforcement Officer, provide Material Safety Data Sheets and inventory information on those Regulated Substances and evidence and/or documentation of the applicable BMP's being used to manage them. Information including, but not limited to, types, quantities, containment, and location of Regulated Substances may be required either in writing or verbal form at the discretion of the Enforcement Officer. Forms and guidance for reporting may be obtained from the Enforcement Officer
2. Falsifying of Information. No person shall make any false statement, representation or certification in any report or any other document filed or required to be maintained pursuant to this resolution.
3. Retention of Records. Any reports or records compiled or submitted pursuant to this section shall be maintained by the user for a minimum of five (5) years or so long as enforcement or judicial proceedings are being pursued, whichever is longer.
4. Guidance. Forms and guidance for regulated substance reporting may be obtained from the Enforcement Officer.

413.11 Enforcement

Enforcement Officer. In accordance with Section 523 of this Resolution, the Xenia Township Enforcement Officer or his/her designee, shall administer, implement, and enforce the provisions of this Section. When considering the exercise of any of the following authorities or actions, the Enforcement Officer shall consult with the appropriate administrative official of any potentially affected community water supply system. Such consultation shall determine what measures need to be taken to ensure the public water supply is reasonably and adequately protected from contamination for the present and the future.

1. Exemption of Regulated Substances. The Enforcement Officer is authorized to exempt certain Regulated Substances that pose no threat to ground water, from the provisions of these regulations. The Enforcement Officer shall maintain and make available a list of all Regulated Substances that are exempted from these regulations. Decision of the Enforcing Officer is subject to appeal to the Xenia Township Board of Zoning Appeals, in accordance with Section 600 of the Xenia Township Zoning Resolution.
2. Notice of Violation. Any person found in violation of any provisions of this Section or any other requirement, rule or regulation issued under the authority of this Section will be served with a written notice stating the nature of the violation and providing reasonable time for compliance, provided however, written notice of violation may be waived under the conditions heretofore described in this Section and provided further, that if the Enforcement Officer has previously promulgated a schedule of compliance or issued an order addressing the same type of or a similar violation and the time for compliance has passed, the Enforcement Officer may dispense with establishing another time period for compliance.
3. Public Water Supply Protection Authority. If any activity or use of Regulated Substance is deemed by the Xenia Township Enforcement Officer to pose a real and present danger of contaminating surface and/or groundwater that would normally enter the public water supply, the Enforcement Officer is hereby authorized to:
 - a. Notify the Public Water Purveyor.
 - b. Cause cessation of said activity or use of the regulated substance; and

- c. Require the provision of administrative controls and/or facilities sufficient to mitigate said danger; and/or
 - d. Cause the provision of pollution control and/or abatement activities; and
In recognition of the sensitive nature of the aquifer, additional and/or emergency enforcement may be necessary. Written notice may be waived in event an activity or use poses a real and present danger of contamination to the surface and/or groundwater. In addition, the Enforcement Officer will notify the appropriate administrative official of any action taken.
4. Liability. Any entity or person who spills, leaks or discharges contaminates shall be liable for any expense, loss or damages, including cleanup, incurred by Xenia Township or any other affected party.
 5. Violation. Whoever violates and is found guilty of any provisions of this resolution are subject to the penalty provisions as outlined in Section 523.7, Enforcement and Penalties, of this Resolution.
 6. Inspections. Subject to applicable provisions of law, the Enforcement Officer or authorized designee bearing proper identification, shall be permitted to enter private property at any reasonable time, with reasonable cause or with prior notification, for such purposes as inspection, observation, measurement, sampling, and records examination pertaining to the requirements of this Zoning Resolution to ensure that activities are in accordance with the provisions of this Section. If the owner or tenant does not consent to the entry of the Enforcement Officer for the above stated purposes, the Enforcement Officer may apply to a court of proper jurisdiction for an appropriate order or other authority to enter said property.

SECTION 414 PUD - PLANNED UNIT DEVELOPMENT

(Subject to 412 Flood Plain Overlay and Section 413 Well Field Overlay)

414.1 Intent and Purpose

This Article is intended to permit the creation of Planned Development Districts. This district is a zoning change within Article VII and has been established for the purpose of conserving land through more efficient allocation of private lots, multi-family dwelling units, common grounds, non-residential uses, greater efficiency in providing public and utility services, and securing benefits from new techniques in community development. Such regulations need not be uniform, but may vary in order to promote the public health, safety and welfare.

414.2 Types of Planned Development Districts

PD-R Planned Residential Development

PD-B Planned Business Development

PD-M Planned Industrial Development

414.3 Criteria for Planned Development Approval

The Township Trustees shall not approve an application for a Planned Development District unless it shall, in each specific case, make specific findings of fact directly based upon the particular evidence presented to it, which support conclusions that:

1. The development can be substantially completed within the period of time specified in the schedule of development submitted by the developer.
2. The site will be accessible from public roads that are adequate to carry traffic that will be imposed upon them by the proposed development and the streets and driveways on the site of the proposed development will be adequate to serve the residents or occupants of the proposed development.
3. The development will not impose an undue burden on public service and facilities such as fire and police protection, water and sewer services and transportation network.
4. The Development Plan contains such proposed covenants, easements and other provisions relating to the proposed development standards, as reasonably required for the public health, safety and welfare.
5. The location and arrangement of structures, parking areas, walks, lighting and appurtenant facilities will be compatible with the surrounding land uses, and any part of a planned development not used for structures, access ways, parking and loading areas will be landscaped or otherwise improved;
6. When business or industrial structures or uses in a Planned Development District about an "R" District, screening shall be provided. In no event shall a business or industrial structure in a "PD" District be located nearer than one hundred (100) feet to an "R" District.

414.4 Pre-Application Consultation

A developer is encouraged to engage in informal consultation with the Zoning Inspector, Regional Planning and Coordinating Commission (RPCC) staff, County Engineer and Sanitary Engineer prior to the filing of any application; however, no statement or representation by such persons shall be binding on either the Zoning Commission or the Township Trustees.

414.5 Developer's Options

1. The developer shall have the following options:
 - a. Submission of a Pre-Development Plan, processed in the manner hereinafter set forth, and the subsequent submission of a Final Development Plan for any

portion of the approved Pre-Development Plan the Developer desires to develop,
or

- b. Submission of a Final Development Plan without a Pre-Development Plan and processed in the manner as hereinafter provided for.
2. No Zoning Certificate shall be issued for any property for which a Planned Development classification is requested and no construction shall begin until an approved Final Development Plan is in effect for that phase or property, whichever of the above options is elected by a Developer.
3. No use shall be established or changed, and no structure shall be constructed in any portion of a Planned Development until the final subdivision plat for that portion has been approved by the RPCC and recorded in compliance with the requirements of the Subdivision Regulations for Greene County. Such plat shall show or include the following:
 - a. Site arrangements, water, sewer/streets, and other public utilities and/or facilities; land to be publicly or commonly owned and maintained.
 - b. Deed restrictions, protective covenants and other legal statements or devices to be used to control use, development and maintenance and shall be consistent with the approved Final Development Plan.

414.6 Submission of Pre-Development Plan

Eighteen (18) copies of a Pre-Development Plan and one (1) 8 1/2 " x 11" Photostat of the Pre-Development Plan shall be submitted with the application and shall include in text and map form, the following:

1. A survey of the tract that is to be developed showing existing features of the property including streets, alleys, easements, utility lines, existing land use, general topography and physical features.
2. A preliminary site plan showing the approximate areas and arrangement of the proposed uses, the relationship of abutting land uses and zoning districts, proposed lots and amount of buildable area within each lot. Included on this site plan, the location and arrangement of the proposed parks, playgrounds, school sites, recreational facilities and the points of ingress and egress of the Development including access to streets where required.
3. Evidence that the applicant has sufficient control over the tract to complete the proposed plan, including a statement of all the ownership and beneficial interests in the tract of land and the proposed "PD" District Development.
4. In the case of a Business or Industrial "PD" District, a statement identifying the principal types of office, business and/or industrial uses that are to be included in the proposed development, their approximate location and intensity of development.
5. In the case of residential, a statement identifying the density of the various residential uses in the development.
6. A statement describing the provision that is to be made for the care and maintenance of open space or recreational facilities, and
7. Any other information required by the Zoning Commission or Trustees.

414.7 Procedure for Approval of Pre-Development Plan

1. The Township staff or designee shall study the material received and confer with other agencies of government as appropriate in the case, to determine general acceptability of the proposal submitted. At a minimum, Township staff will consult the County Engineer, Sanitary Engineer and Planning Commission staff.

2. The Zoning Commission, per this Resolution, shall hold a Public Hearing on the proposed Pre-Development Plan.
3. The recommendation of the Zoning Commission to the applicant shall be in writing and following any such Public Hearing, agreements between the applicant and the Zoning Commission as to changes in the Pre-Development Plan and report or other matters shall be recorded and acknowledged by the Zoning Commission and the applicant at a Public Hearing. On items on which no agreement is reached, or there is specific disagreement, this fact shall be recorded, and the applicant may place in the record his reasons for any disagreement.
4. When the Pre-Development Plan and report have been approved in principle (as whole or with reservations duly noted), or when the applicant indicates in writing that no further negotiations with the Zoning Commission are desired before proceeding, the Commission shall, within thirty (30) days, make its recommendations to the Township Trustees. Such recommendations shall indicate approval, approval with modifications, or disapproval. With such recommendations, the Commission shall transmit to the Township Trustees, and make available to the public, the latest draft of the Pre-Development Plan and report submitted by the applicant, a record of agreements reached and matters on which there were no specific agreements, including any reasons recorded by the applicant for any such disagreement.

414.8 Action by the Township Trustees

The Township Trustees shall hold a Public Hearing on the Pre-development Plan as provided for in this Resolution.

If the application is granted, the area of land involved shall be re-designated as a "PD-R", "PD-B" or "PD-M" District by resolution and such resolution shall incorporate the Pre-Development Plan, including any condition or restriction that may be imposed by the Township Trustees.

This step shall be an amendment as provided in Article VII and ORC 519.12.

414.9 Submission of Final Development Plan in Accordance with an Approved Pre-Development Plan

Final Development Plan may be filed for any portion of an approved Pre-Development Plan the applicant wished to develop and it shall conform to the approved Pre-Development Plan. The filing fee shall be the same as the required for a change in Zoning District. Eighteen (18) copies of the Final Development Plan and one (1) 8 1/2"x 11" photostat of the Final Development Plan shall be submitted and shall include in text and map form:

1. A site plan showing the location and arrangement of all existing and proposed structures, the proposed traffic circulation pattern within the development, landscaping the areas to be developed for parking, the points of ingress and egress including access streets where required, the relationship of abutting land uses and zoning districts, proposed lots and blocks, if any, and proposed public or common open space, if any, including parks, playgrounds, school sites and recreational facilities.
2. A statement of the density, the proposed total gross floor area, and the percentage of the development which is to be occupied by structures
3. Sketches of the proposed structures.
4. When a Planned Development is to be constructed in stages or units, a schedule for the development of such stages or units shall be submitted. No such stage or unit shall have a density that exceeds by more than twenty percent (20%) the density of

the entire Planned Development. When a Planned Development provides for common open space, the total area of common open space provided at any stage of development shall, at a minimum, bear the same relationship to the total open space to be provided in the entire Planned Development as the stages or units completed or under development bear to the entire Planned Development.

5. Evidence that the applicant has sufficient control over the tract to affect the proposed plan, including a statement of all the ownership and beneficial interests in the tract of land and the proposed development.
6. In addition to the final site plan, in the case of a Business or Industrial Planned Development, a statement identifying the principal types of offices, business and/or industrial uses that are to be included in the proposed development.
7. When a Planned Development includes provisions for common open space or recreation facilities, a statement describing the provision that is to be made for the care and maintenance of such open space or recreational facilities. If it is proposed that such open space be owned and/or maintained by an entity other than a governmental authority, copies of the proposed articles of incorporation and by-laws of such entity shall be submitted.
8. Copies of any restrictive covenants that are to be recorded with respect to property included in the Planned Development District.
9. Any other information required by the Trustees.

414.10 Procedure for Approval of Final Development Plan with Approved Pre-Development Plan

1. The Township staff or designee shall study the material received and confer with other agencies of government as appropriate in the case, to determine general acceptability and conformance to approve the Pre-Development Plan.
2. The Zoning Commission shall hold a public meeting on the proposed Final Development Plan. All property owners within 500 feet of the project shall be notified.
3. The recommendations of the Zoning Commission to the applicant shall be in writing. Agreements between the applicant and the Zoning Commission as to changes in the Final Development and report or other matters shall be recorded and acknowledged by the Zoning Commission and the applicant at the public meeting.
4. Recommendations by the Zoning Commission shall indicate approval, approval with modifications, or disapproval. With such recommendations, the Commission shall submit to the Township Trustees, and make available to the public the latest draft of the Final Development Plan and report submitted by the applicant.
5. At a public meeting the Township Trustees shall evaluate the Zoning Commission's recommendation and Final Development Plan to consider all aspects thereof and determine whether or not it is in accord with the approved Pre-Development Plan. The Township Trustees shall disapprove, approve or approve the Final Development Plan with amendments, conditions or restrictions. If the Plan is approved, the Plan shall be incorporated into the Zoning Resolution and that District for which the Plan is proposed, including any condition or restriction that may be imposed by the Township Trustees. Upon approval by the Township Trustees, the Final Development Plan will go into immediate effect.
6. Approval of a Final Development Plan as being in compliance with the standards of approval established under this section shall not be considered an amendment or

supplement to the township zoning resolution for the purpose of Section 519.02 of the Ohio Revised Code.

414.11 Submission of Final Development Plan Without an Approved Development Plan

The applicant need not file a Pre-Development Plan if he files a Final Development Plan for his entire site incorporating all requirements of both Pre and Final Development Plans as described in this Section. The Final Development Plan shall be processed, noticed and heard in the manner prescribed herein. Eighteen (18) copies of the final Development Plan and one (1) 8 1/2" x 11" Photostat of the Final Development Plan shall be submitted and shall include in text and map:

1. A survey of the tract that is to be developed showing existing features of the property, including street, alleys, easements, utility lines, existing land use, general topography and physical features.
2. A site plan showing the location and arrangement of all existing and proposed structures, the proposed traffic circulation pattern within the Development, landscaping, the area to be developed for parking, the points of ingress and egress including access streets where required, the relationship of abutting land uses and zoning districts.
3. A statement of the density of the various Residential uses within the development, when applicable, the proposed total gross floor area, and the percentage of the development which is to be occupied by structures.
4. Sketches of the proposed structures and landscaping.
5. When a Planned Development is to be constructed in stages or units, a schedule for the development of such stages or units shall be submitted. No such stage or unit shall have a density that exceeds by more than twenty percent (20%) the density of the entire Planned Development. When a Planned Development provides for common open space, the total area of common open space provided at any stage of development shall, at a minimum, bear the same relationship to the total open space to be provided in the entire Planned Development as the stages or units completed or under development bear to the entire Planned Development.
7. Evidence that the application has sufficient control over the tract to affect the proposed plan, including a statement of all ownership and beneficial interests in the tract of land and the proposed Development.
8. In the case of an Office, Business or Industrial Planned Development, a statement identifying the principal types of office, business and/or industrial uses that are to be included in the proposed development.
9. When a Planned Development includes provisions for common open space or recreational facilities, a statement describing the provision that is to be made for the care and maintenance of such open space be owned and/or maintained by any entity other than a governmental authority, copies of the proposed articles of incorporation and by-laws of such entity shall be submitted.
10. Copies of any restrictive covenants that are to be recorded with respect to property included in the Planned Development District.
11. Any other information required by the Zoning Commission or Trustees.

414.12 Action by the Township Zoning Commission on Single State Development Plan

The Zoning Commission shall hold a public hearing on the Final Development Plan as provided by this Resolution. Such public hearing shall consider all aspects of the Final Development Plan including any proposed stages and/or units of development. The Zoning Commission shall prepare and transmit to the Township Trustees and to the applicant, specific findings of fact with respect to the extent to which the Final Development Plan

complies with the standards set out in this Article and the District for which the change has been requested, together with its recommendations to the Township Trustees with respect to the action to be taken on the Final Development Plan. The Zoning Commission may recommend disapproval, approval, approval with amendments, conditions or restrictions. Copies of the findings and recommendations of the Zoning Commission shall be made available to any other interested persons.

When at the option of the applicant, a single final development plan is submitted without an approved Pre-Development Plan, the action of the Board of Trustees shall be considered an amendment as provided for in Article VII.

414.13 Action by the Board of Township Trustees

The Township Trustees shall hold a public hearing on the Final Development Plan as provided by this Resolution. If the application is granted, the area of land involved shall be re-designated as a "PD-R", "PD-O", "PD-B" or "PD-1" District by resolution and such resolution shall incorporate the Plan, including any condition or restriction that may be imposed by the Township Trustees.

414.14 Extension of Time or Modification

An approved Pre-Development or Final Development Plan may be amended by following the procedures described in this Article. However, minor adjustments in the Final Development Plan which become necessary because of field conditions, detailed engineering data, topography or critical design criteria pertaining to drives, curb cuts, retaining walls, swimming pools, tennis courts, fences, building locations, and building configurations, parking area locations or other similar project particulars, may be authorized in writing by the Township Trustees. These minor adjustments may be permitted, provided that they do not increase density, decrease the number of parking spaces or allow buildings closer to perimeter property lines. The Trustees shall approve, disapprove or modify all minor adjustments.

414.15 "PD-R" Planned Residential District

1. Principal Permitted Uses

- a. Residential use development in a unified manner in accordance with the approved Development Plan.
- b. Uses permitted in any Residential District.
- c. Convenience establishments may be permitted if specifically approved a part of the Plan, provided that the areas and structures occupied shall be so located and designed as to protect the character of the surrounding property, and provided further that convenience establishments shall be subject to additional requirements as herein specified:
 - (1) Such establishments and their parking spaces shall not occupy more than five (5%) percent of the total area of the development.
 - (2) Such establishments shall be so located, designed and operated as to serve primarily the needs of persons within the Development Plan and not persons residing elsewhere.
 - (3) Off-street parking and loading requirements shall be appropriate to the particular case based upon the types of convenience establishments permitted and the anticipated proportion of walk-in trade. Multiple use of off-street parking and service area and access ways or convenience establishments may be permitted, if such multiple use will not lead to congestion or the creation of hazards to pedestrian or vehicular traffic.

2. Development Standards
 - a. (Single-Family) PD-R-1. A Single Family Residential "PD" development shall meet those established setback requirements, minimum lot or open space, height regulations, minimum rear yard of the abutting zone on the perimeter buildings of the project. However, "R-1" district standards shall be observed as minimum on perimeter buildings. Structures built on the interior of the project shall have flexibility as to layout and there shall be no minimum lot size, however, the maximum density of Article 414.15 shall apply.
 - b. Planned Development Residential (Multi-Family) PD-RM. Multi-family residential "PD" buildings shall meet those established setback requirements, general area, height regulations, minimum rear and minimum side yard requirements of the abutting zone on the perimeter buildings of the project. However, "R-3" district standards shall be observed as a minimum on perimeter buildings. Nothing in this paragraph is intended to set a minimum lot size. Structures built on the interior of the project shall have flexibility as to layout (minimum distance between buildings shall be 20 feet with the average for the entire project of 30 feet between buildings and there shall be no minimum lot size; however, the maximum density of Article 414.15 shall apply.
 - c. Maximum density for single family development shall be two (2) dwelling units per gross acre and maximum density for multi-family development shall be eight (8) dwelling units per gross acres.
 - d. The final development plan required by Article 400 Planned Development shall be prepared in conformance with the above and in conformance with the applicable Sections.
 - e. Accessory uses are permitted as in R-1 through R-3 Districts.
3. Required Conditions
 - a. The regulations of any "PD" District shall be uniform throughout any one "PD-R" District and shall include but without limitation the following where applicable:
 - (1) Conditions of use.
 - (2) Public streets and sidewalks.
 - (3) District buffer strips.
 - (4) Parking and loading.
 - (8) Height and area standards.
 - (9) Lighting.
 - (7) Landscaping.
 - (10) Open space and provision for maintenance and/or neighborhood playground or public park.
 - (11) Signs.
 - b. The regulations of said "PD-R" District shall be finalized by the Board of Township Trustees at the time the district is established and, except as otherwise permitted in this section, shall be equal to the following:
 - (1) Insofar as practical the regulations of the most restrictive district adjoining the proposed "PD-R" District.
 - (2) Any other more restrictive regulations which in the opinion of the Board of Township Trustees should apply.

4. Parking and Loading
Off-street parking and loading spaces shall be required as set forth under the General Regulations of Off-Street Parking and Loading Areas.

414.16 "PD-B" Planned Business District

1. Principal Permitted Uses

The following Planned Development Business Districts shall be allowed:

PD-B1
PD-B2
PD-B3

The uses and height restrictions applicable to the B-1 shall apply to the PD-B1. The uses and height restrictions applicable to the B-2 shall apply to the PD-B2. The uses and height restrictions applicable to the B-3 shall apply to the PD-B3.

Residential and office uses developed in a unified manner in accordance with the "PD-R" Districts.

2. Development Standards

In addition to the provisions of the General Regulations, the following standards for arrangement and development of land and building are required in the "PD-B" District.

- a. Land Occupancy by Buildings: Total land occupancy by all buildings for a "PD-B" District shall not exceed sixty (60%) percent of the area of the tract, provided however, that underground parking structures, the highest portions of which are not more than thirty (30) inches above the level of the centerline of the nearest adjacent street, shall not be included in computations of land occupancy by buildings.
- b. Open Space Requirements: Open space shall be a minimum of twenty (20%) percent of the land area and shall not be used or occupied by automotive vehicles. Such space shall be reserved for landscaping, and its location use and other improvements shall be consistent with the character of the site and its relation to the general area in which it is located.
- c. Development Plan: The Specific Development Plan required by Article 400, Planned Development, shall be prepared in conformance with the above and with the Required Conditions and the Standards for Planned Development as set forth in Planned Development.

When a Residential District abuts the retail, service and/or office uses of the PD-B1, PD-B2 or PD-B3 then the residential districts yard requirements shall be applicable.

3. Parking and Loading

Off-street parking and loading spaces shall be required as set forth in General Regulations and Off-Street Parking and Loading Area.

414.17 "PD-M" Planned Industrial District

1. Principal Permitted Uses

Uses permitted in the "M-1" District that are manufacturing, processing, warehousing and/or industrial service activities developed, operated and maintained within an organized development of associated activities in accordance with the approved Development Plan.

2. Development Standards

In addition to the provisions of General Regulations the following standards for arrangement and development of land and building are required in the "PD-M" District.

- a. Land Occupancy by Buildings:
Total land occupancy by all buildings for a "PD-M District shall not exceed sixty (60%) percent of the area of the tract.
 - b. Site Planning:
The same requirements applicable to the "PD-R" District shall apply to "PD-M" District. In addition, yards with a minimum width of 100 feet shall be provided along all property lines.
3. **Parking and Loading**
Off-street parking and loading spaces shall be required as set forth in General Regulations.

SECTION 415 R-MH MOBILE HOME PARK/COMMUNITY DISTRICT

415.1 Intent and Purpose

This District has been established to provide for Mobile Homes in Mobile Home Parks/Communities. It is intended that Mobile Home Parks/Communities be located along a street of sufficient width to provide easy access without traffic congestion and without creating traffic hazards in surrounding areas.

415.2 Permitted Principal Uses

No mobile home shall be used for any purpose other than a single-family residence.

415.3 Accessory Uses

1. Recreational facilities for residents of Mobile Home Parks/Communities.
2. Accessory uses customarily incidental to the Permitted Principal Use.

415.4 Yard Requirements

1. The minimum acreage of the Mobile Home Park/Community District shall not be less than ten (10) acres.
2. The minimum road frontage for a Mobile Home Park/Community District shall be six hundred (600) feet.

415.5 The R-MH District is regulated by the Manufactured Homes Commission in compliance with Chapter 4781 of the Ohio Revised Code of the Ohio Administrative Code.

415.6 Signs

1. See Article V, Section 517 for size and location of permitted signs.

ARTICLE V - GENERAL PROVISIONS

SECTION 500 GENERAL REGULATIONS

Except as herein provided, no building or structure shall be erected, converted, enlarged, reconstructed, moved or structurally altered, nor shall any building or land be used:

1. Except for a purpose permitted in the district in which building or land is located.
2. Except in conformance to the height or bulk limits established herein for the district in which the building or use is located.
3. Except in conformance to the yard and lot regulations of the district in which the building or use is located.
4. Except in conformance to the off-street parking and off-street loading space regulations of the district in which the building or use is located.
5. Unless such building or structure is located on a lot as herein defined, and in no case shall there be more than one main building on a lot in R-Residential Districts.

500.1 Applicability

It shall be the responsibility of any person owning real property and/or owning or operating a business within Xenia Township to make a determination of the applicability of this Section as it pertains to the property and/or business, and failure to do so shall not excuse any violations of this Section.

SECTION 501 YARD REQUIRED FOR CORNER AND THROUGH LOTS

1. In any district the side yard of a corner lot that abuts the side street shall have the same setback requirements as the front yard.
2. A rear yard shall be provided parallel to and opposite from the front yard.
3. On through lots the front yard requirements shall apply to all street frontages.

SECTION 502 CORNER LOT ACCESSORY BUILDING

Where a corner lot adjoins the side boundary of a lot in a residential zone, no part of any accessory building within twenty-five (25) feet of the common lot line shall be nearer the street bounding the side lot line than the least depth of any front yard required along such side street. Where compliance would give impractical depth to a private garage, the Board of Appeals may grant a variance in the front yard requirement along such side street, but in no case shall such garage project beyond the building to which it is accessory, be closer than three (3) feet to a common lot line, be located closer than ten (10) feet to the rear lot line of the lot on which it is to be located.

SECTION 503 LOTS ADJOINING ALLEYS

In calculating the area of a lot that adjoins an alley, for the purpose of applying the lot area requirements of this resolution, one-half (1/2) the width of such alley abutting the lot shall be considered as part of such lot.

SECTION 504 ACCESSORY BUILDING

- 1 No garage or accessory building shall be erected within a required side yard or front yard.
- 2 The accessory building may be erected not less than eight (8) feet from the side or rear lot lines nor less than eight (8) feet from the main building.
3. When not located completely to the rear of the dwelling, garages shall be constructed as a part of the main building or connected thereto by a covered breezeway.
- 4 No detached accessory building in Residential and B-1 Districts shall exceed eighteen (18) feet or the height of the residence, whichever is less. The height will be calculated as stated in the building height definition.

- 5 An accessory building may precede construction of a main building, but permit must be submitted with approved septic permit from Greene County Health Department, site plan showing location of septic system, well and main building. If the accessory building precedes the main building, it will be subject to inspection until the main building is completed. Under no circumstance will an accessory building be used for habitation.

SECTION 505 HEIGHT OF FENCES

1. All fences, walls and hedges hereafter erected, constructed or modified shall be exempt from yard and setback requirements of the districts in which they are located. All fences, walls and hedges are prohibited in the right-of-way.
2. No fences, walls or hedges shall be erected, relocated, or maintained so as to delay free ingress to or egress from any door, window or fire escape or in violation of the Ohio Fire Code.
3. No fences, walls or hedges shall be erected at the intersection of any street or driveway in such a manner as to obstruct free and clear vision of roadway traffic.
4. Front gates in any district shall not obstruct free and clear vision through the gate.
5. A. Front yard fences and walls in any R and E Districts shall not obstruct free and clear vision through the fence.
B. Front yard hedges in any R and E Districts shall be maintained to a height no taller than three (3) feet.
6. The max height of fences, walls and hedges by district:

District	Max height
R-1, E	6 feet*
A, R-MH, RM	8 feet
IG, B-1, B-2, B-3, M-1, M-2, M-3	12 feet

*except front yard hedges shall have a max height of 3 feet

SECTION 506 ESSENTIAL SERVICES

Essential services shall be allowed in any district insofar as permitted, authorized, or regulated by law or other Resolution.

SECTION 507 EXTERNAL EFFECTS

1. No land, building or structure in any district shall be used or occupied in any manner so as to create anything dangerous, injurious, noxious, or otherwise objectionable (fire, explosives, or other hazard; noise, brilliant light, vibration; smoke, dust, fumes, odor, or other forms of air pollution; heat, cold, dampness; electrical or electronic disturbances, nuclear radiation, or any other condition, substance or element, as per applicable federal standards) to any person or property outside of the premises on which such building, structure or use is located; such uses when lawfully permitted under the provisions of this Resolution shall be operated in a manner so as to insure that the property rights of all other parcels of land will not be adversely affected to the extent of reducing the enjoyment of property rights thereon
2. The accumulation of trash, junk vehicles, vehicle parts, or any other debris in any district shall be a nuisance per se and shall be prohibited outside of an approved junk yard. The purpose of this section is to promote the health, safety and welfare of Xenia Township by eliminating environments for breeding of vermin, rodents, insects and infestations.

SECTION 508 OUTDOOR STORAGE AND WASTE DISPOSAL

Every use shall be operated in accord with the following provisions:

1. No highly flammable or explosive liquids, solids or gases shall be stored in bulk above ground except for industrial or agricultural uses. Tanks or drums of fuel directly connected with heating devices or appliances located on the same lot as the tanks or drums of fuel are excluded from this provision;
2. No materials or waste shall be deposited upon a lot in such form or manner that they may be transferred off the lot by wind, flood or natural causes or forces;
3. All materials or waste which might cause fumes, dust or which constitute a fire hazard or which may be edible or attractive to rodents or insects shall be stored outdoors in closed containers constructed of impervious material.

SECTION 509 PROJECTIONS INTO REQUIRED YARDS

1. Front Yard: Porches and steps may extend from the dwelling into the required front yard a maximum of ten (10) feet.
2. Rear Yard: Additions such as family rooms, sun rooms, covered porches may extend into the rear yard a maximum of fifteen feet.
3. Side yard: Open structures such as porches, balconies, decks, platforms, carports and covered patios, shall be considered a part of the building to which attached and shall not project into the required minimum side yard.
4. Chimneys, flues, sills, pilasters, cornices, eaves, gutters and other similar features may project into a required side yard a maximum of twenty-four (24") inches.

SECTION 510 EXCEPTIONS TO HEIGHT LIMITATIONS

1. Chimneys and other mechanical appurtenances may exceed district height limitations as necessary.
2. Public, semi-public or public service buildings, in Districts where permitted, may be erected to a height not exceeding twice the maximum permitted building height in the District and the required front, side, and rear yards shall each be each increased by one (1) foot for each foot of additional building height above the height regulations for the District in which the building is located.
3. Towers, architectural features, and antenna support structures may exceed the allowable height of buildings in all Districts provided:
 - a. In Residential Districts the maximum height of all architectural features above grade shall not exceed twice the maximum permitted building height in the district and the required front, side, and rear yards shall each be increased by one (1) foot for each foot of additional feature height above the height regulations for the district in which the building is located.
 - b. In non-residential Districts the maximum height of all architectural features above grade shall not exceed 90 feet and the required front, side, and rear yards shall each be increased by one (1) foot for each foot of additional feature height above the height regulations for the district in which the building is located.
 - c. Extension of guy wires into a required side and rear yard is permitted.
 - d. ORC 5502.031 and 519.211 limit the application of this section concerning wireless communication towers and amateur radio towers.

SECTION 511 TEMPORARY USES

In any district subject to the conditions stated below, the Enforcing Officer may issue a permit for the following temporary uses:

1. Building for residential use or yard for construction office, material or equipment, provided such use is adjacent to the construction site and removed when construction is completed. Each permit issued by the Zoning Inspector shall be valid for six (6) months and may be renewed if construction is underway and shall be removed when construction is completed or discontinued for more than thirty (30) days.
2. Temporary storage unit (pod) shall be permitted for a six (6) month period and may be renewed for an additional six (6) month period.
3. Temporary Office incidental and necessary to real estate sales and rentals. Each permit shall be valid for one (1) year and may be renewed for one (1) additional year if conditions warrant such renewal.
4. Gatherings under canvas or in open: Religious service, show, meeting, exhibition, bazaar, carnival or circus except that if located within four hundred (400) feet of any residential area no permit will be issued unless there is first filed with the Enforcing Officer the written consent of the owners of sixty percent (60%) of all residentially used property within four hundred (400) feet from the place of such meeting.
5. Vendor tents, sales trailer or motor vehicles used for sales, not to exceed fourteen consecutive days.

SECTION 512 MAJOR STREET SETBACKS

Any building or structure shall hereafter be constructed in accordance with the required front yard setback in the district in which it is to be located, measured from the required right-of-way line on major streets and secondary streets designated as such on the Major Thoroughfare Plan.

SECTION 513 OFF-STREET LOADING REGULATIONS

On the same premises with every building or structure or part thereof, erected and occupied for commerce, industry, public assembly, or other uses involving the receipt or distribution by vehicles of materials or merchandise, there shall be provided and permanently maintained adequate space for standing, loading and unloading services in order to avoid undue interference with public use of the streets or alleys in conformance to the following:

513.1 General Provisions

1. Screening - Off-street loading spaces that adjoin or are across a street from property zoned for any residential use, shall have a dense evergreen planting, fence, masonry wall or such other screening as determined in Article 515.
2. Entrances and Exits - Off-street loading spaces shall be provided with entrances and exits not less than twelve (12) feet in width and so located as to minimize traffic congestion.
3. Dimensions - Each off-street loading space shall be not less than ten (10) feet in width, twenty-five (25) feet in length and fifteen (15) feet in height.
4. Projections into Yards - Off-street loading space may occupy all or any part of any required rear yard space.

513.2 Amount of Loading Space Required

The minimum amounts of off-street loading space shall be provided according to the table below. An area adequate for maneuvering, ingress and egress shall be provided in addition to required loading space.

	Square Feet of Gross Floor Area	Required No. of Spaces
a.	Up to 10,000 sq. ft.	1
b.	10,001 to 20,000 sq. ft.	2
c.	20,001 to 40,000 sq. ft.	3
d.	40,001 to 75,000 sq. ft.	4

- | | | |
|----|------------------------------------|----------------------------|
| e. | 75,001 to 125,000 sq. ft. | 5 |
| f. | For each additional 50,000 sq. ft. | 1 additional loading space |

SECTION 514 OFF-STREET PARKING REGULATIONS

Hereafter, no building shall be erected or altered, and no land used unless there be provided adequate off-street parking space or spaces for the needs of tenants, personnel and patrons together with means of ingress or egress.

514.1 General Provisions

1. Residential off-street parking spaces shall consist of a parking strip, driveway, garage, or combination thereof and shall be located on the premises they are intended to serve.
2. Any area once designated as required off-street parking shall not be changed to any other use unless and until equal facilities are provided elsewhere.
3. Off-street parking existing at the effective date of this Resolution in connection with the operation of an existing building or use shall not be reduced to an amount less than hereinafter required for a similar new building or new use.
4. Two or more buildings or uses may collectively provide the required off-street parking in which case the required number of parking spaces shall not be less than the sum of the requirements for the several individual uses computed separately.
5. In the instance of dual function of off-street parking spaces where operating hours of buildings do not overlap, the Board of Appeals may grant a conditional use.
6. The storage or sale of merchandise or the repair of vehicles is prohibited.
7. For those uses not specifically mentioned, the requirements for off-street parking facilities shall be in accord with a use which the Board of Appeals considers as being similar in type.
8. Ingress and Egress: A suitable means of ingress or egress for vehicles to premises used for parking shall be provided, and shall open directly from and to a public street or highway. The width of any exit, or entrance, adjoining property or opposite property zoned for residential uses shall be approved by the Township Zoning Inspector prior to obtaining any permit.
9. Fencing, wheel stops, or other physical barriers shall be provided for all boundaries of the parking area except at points of ingress and egress to prevent encroachment of vehicles.
10. Pavement: All parking lots shall be surface with a hard or semi-hard dust free surface.
11. Lighting: If the parking lot is to be open for use after dark, it shall be provided with not less than two (2) lumens of light per square foot of parking lot surface. Lights shall be shielded so as not to shine directly or in any offensive manner on the adjoining residential property.
12. Screening: When a parking lot abuts a residential zone, there shall be permanently maintained along such boundary, screening as provided in Section 515.
13. Plot Plan to be Filed: Prior to constructing an accessory parking lot, the owner or person in charge of the land to be used for parking shall submit a plot plan to the Enforcing Officer or Clerk who will submit the same to the Township Zoning commission, and other agencies for their consideration and recommendations. Such plot plan shall show the boundaries of the property, location of adjacent houses, parking spaces, circulation patterns, drainage plan and construction plan for boundary walls and planting plan.

14. Restricted Accessory Parking Areas: The Board of Appeals may permit accessory parking within an adjacent lot zoned for residential use, providing:
 - a. Such lot is necessary for the public convenience and will not have an adverse effect on adjacent properties.
 - b. A public hearing is held in accordance with the procedure given in Section 600.8.
 - c. All provisions of Section 514 of this Resolution are complied with.
 - d. No parking shall be permitted between the street line and the building line prevailing in the zone in which the proposed parking area is to be located. The resulting open area shall be planted in grass, or otherwise landscaped to create a permanent green area.
 - e. A dense evergreen planting with a minimum height of four (4) feet and a mature height of at least five feet, six inches (5'6"), or solidly constructed decorative fence shall be permanently maintained along the mutual boundary of the restricted accessory parking area and adjacent land zoned for residential uses except for the portion of such boundary located within a required front yard.
 - f. Whenever a lot located in a residential zone is used for accessory parking purposes and is located across the street from land in a residential zone, that portion of the lot used for parking purposes shall be screened from the street as specified in paragraph 5 above except for access drive. Such screening to be placed along the setback line.
 - g. Ingress and egress for vehicles to a premises used for parking under Conditional Use Permit by the Board of Appeals shall be by means of streets through business or industrial areas, not by means of streets through residential area.

514.2 Amount of Off-Street Parking Spaces Required

The amount of required off-street parking spaces for new uses or buildings, additions thereto, and additions to existing buildings, shall be determined in accordance with the following minimum parking provisions:

1. One-family Dwelling: Two spaces for each family unit.
2. Two-family Dwelling: Two parking spaces for each family.
3. Multiple Family: Two parking spaces per dwelling unit plus one space per each employee.
4. Apartment-Hotel: One space per apartment, plus one for each employee.
5. Housing for the elderly: One parking space for each two units, plus one space for each employee.
6. Boarding House: One parking space for each sleeping room.
7. Hotel or Motel: One space per unit, plus one for each employee.
8. Churches: One parking space for each three seats in the main auditorium.
9. Hospitals: One for each two beds, plus one for each staff doctor, plus one for each two full-time employees on shift, including nurses.
10. Convalescent Homes or Children's Homes: One for each two beds, plus one for each two employees.
11. Elementary and Junior High Schools: One parking space for each employee, plus one parking space for each eighty (80) square feet in the main auditorium, not containing fixed seats, or one space for six (6) fixed seats in the main auditorium whichever is greater.
12. Senior High Schools: One (1) parking space for each employee, plus one (1) parking space for each ten (10) students, or one (1) parking space for each eighty (80) square feet of floor area in the main auditorium not containing fixed seats, or one (1)

- parking space for each six (6) fixed seats in the main auditorium whichever is greater.
13. College and Business University: One (1) for each two (2) employees, plus one (1) for each three (3) students.
 14. Libraries, Museums or Art Galleries: One (1) for each six hundred (600) square feet of floor area, plus one (1) for each four (4) employees.
 15. Post Office: One (1) for each five hundred (500) square feet of floor area, plus one (1) for each three (3) employees.
 16. Private Clubs, Lodges: One (1) parking space for each three (3) persons allowed by fire, health or building code.
 17. Bowling Alleys: Five (5) parking spaces for each alley.
 18. Public Golf Courses: Six (6) parking spaces for each golf hold, plus one (1) space for each employee.
 19. Sports Arenas, Auditoriums, Theaters, Assembly Halls (other than in schools): One (1) parking space for each four (4) persons allowed by the fire code up to 1000 seats, plus one (1) parking space for each three (3) persons allowed by the fire code over 1000 seats, plus one (1) for each two (2) employees.
 20. Stadium, Sports Arena or Similar Place of Outdoor: One (1) parking space for each three (3) seats.
 21. Professional Offices, Medical Clinics: One (1) parking space for each one hundred and fifty (150) square feet of floor area. Provided that professional offices, when used as a home occupation, shall provide one (1) parking space for each one hundred (100) square feet, or major fraction thereof, of office area in addition to that required for the residing family or families.
 22. Office Buildings: One (1) parking space for each two hundred (200) square feet of gross floor area excluding any floor space used for parking.
 23. Banks, Dry Cleaners, Laundries, and Similar Service Business: One (1) parking space for each two hundred and fifty (250) square feet of floor area.
 24. Drive-In Banks With Inside Customer Service: Five (5) for each teller window, plus one (1) for each employee; without inside customer service, one (1) space for each employee.
 25. Auto Service Stations: Six (6) spaces.
 26. Automobile Sales and Service Garage: One (1) parking space for each two hundred (200) square feet of floor area in the main display room plus one space for each employee.
 27. Used Car Lot: One (1) space for each two thousand four hundred (2400) square feet of lot area.
 28. Barber Shops and Beauty Parlors: One (1) for each chair, plus one (1) for each employee.
 29. Drive-In : One (1) parking space for each sixty (60) square feet of floor area, but not less than twenty (20) employees.
 30. Furniture and Appliances, Household Equipment Decorator, Electrician, Shoe Repair: One (1) parking space for each eight hundred (800) square feet of floor area plus one (1) space for each two (2) employees.
 31. Laundromats: One (1) space for each two washing machines.
 32. Mortuaries or Funeral Homes: One parking space for each fifty (50) square feet of floor area in the slumber rooms, parlors, or individual funeral service rooms.
 33. Restaurant, with only inside service, or Tavern:

- One (1) parking space for each four (4) seats, plus one (1) space for each two (2) employees.
34. Retail Stores: (including rental service stores):
One (1) parking space for each two hundred (200) square feet of gross floor area; excepting self-service or supermarket which shall provide one (1) parking space for each one hundred (100) square feet of gross floor area.
 35. Contractors Yard or Plant Storage Yard: One (1) space for each three employees.
 36. Warehouses, Wholesale Stores: One (1) parking space for each eight hundred (800) square feet of floor area.
 37. Manufacturing Plants or Research Laboratories:
One (1) space for each one and one-half (1 1/2) employees per largest work shift. In the case of a use not specifically mentioned, the requirements for off-street parking shall be the same as for a similar use specifically mentioned. Similarity to be determined by Enforcing Officer.

SECTION 515 SCREENING

Screening shall be required for non-residential buildings, structures or land uses on a lot that adjoin or face any residential district. The plan for screening shall be submitted to and approved by the Zoning Inspector. Screening shall comply with Section 505.

515.1 Purpose of Screening

Screening shall be provided for one or more of the following purposes:

1. A visual barrier to partially or completely obstruct the view of structures or activities not conducive to a residential area.
2. As an acoustic screen to aid in absorbing or deflecting noise.
3. For the containment of debris and litter.

515.2 Type of Screening

Screening may be one of the following or a combination of two or more:

1. Fence
2. Hedge (evergreen)
3. Earth and mound

SECTION 516 DELETED

SECTION 517 PERMITTED SIGNS

517.1 Scope of Regulations

1. The regulations herein set forth shall apply and govern in all districts. No sign shall be erected or maintained unless it is in compliance with the regulations for the district in which it is located. No sign shall be erected or continued in operation in any manner constituting a nuisance because of glare, focus, animation or flashing.
2. All signs hereafter erected, constructed or modified shall be exempt from yard and setback requirements of the districts in which they are located. All signs are prohibited in the right-of-way.
3. Where permitted, all illuminated or electronic signs shall be designed, constructed, and operated so as to prevent glare upon the street or adjacent property. Both strobe and full motion video effects are prohibited. Such illuminated or electronic messages shall be turned off no later than 11:00 P.M. when such sign is within two hundred (200) feet of an R-1, RM, R-MH, or E District.
4. No sign shall be erected, relocated, or maintained so as to delay free ingress to or egress from any door, window or fire escape.

5. No sign shall be erected at the intersection of any street or driveway in such a manner as to obstruct free and clear vision of roadway traffic.
6. No sign shall be erected at any location where, by reason of the position, shape or color, it may interfere with, obstruct the view of, or be confused with any Uniform Traffic Control Devices; or which makes use of the words “STOP”, “LOOK”, “DANGER”, or any other words, phrases, symbol or character in such manner as to interfere with, mislead or confuse the public.
7. It shall be unlawful for any person to display upon any sign or other advertising structure any obscene, indecent or immoral matter, including any message or image that identifies sexual activities or anatomical areas in a sexual manner.
8. Maximum height above grade at the top of the sign shall not exceed forty (40) feet.
9. No sign shall be placed nearer than ten (10) feet to an adjacent residential district lot line. Where an illuminated sign face exceeds fifty (50) square feet in area it shall not be placed nearer than fifty (50) feet to an adjacent residential lot line.

517.2 Exemptions

The provisions and regulations of this Resolution shall not apply to the following signs, provided that there is no more than one such sign per use per each street front of the lot on which the sign is located:

1. Memorial signs or tablets, names of building, and date of erection when cut into any masonry surface or when constructed of bronze or other incombustible materials.
2. Traffic or other municipal signs, legal notices, railroad crossing signs, and such temporary emergency, or non-advertising signs as may be authorized by a legislative body.
3. The flag, pennant or insignia of any nation, state, city or other political subdivision.
4. Parking or directional signs not over two (2) square feet in area provided the sign contains no advertising matter.

517.3 Subdivision Signs (Page 85)

Upon application to the Zoning Inspector, a permit may be issued as a special exception to the terms of this Resolution allowing a land-sale sign, provided that:

1. The sign shall advertise the sale or development of a lot subdivision or tract of land;
2. The sign shall be erected only upon the property for sale or being developed;
3. The sign shall not be in excess of forty (40) square feet, either single or double face;
4. Not more than one (1) such sign shall be placed along single road frontage of any property in single and separate ownership, provided that not more than two (2) such signs may be permitted in any single development;
5. A permit for the erection, construction, or maintenance of said sign shall expire within one (1) year.

517.4 Allowable Signage by District (Page 85)

For purposes of determining the allowable square footage of all signs on corner lots, the total lot frontage can be included.

For purposes of determining the distances between large signs, parcels adjacent to, contiguous with, or directly across the street from the parcel in question and owned by the same owner shall be treated as one parcel.

517.4.1 A, R-MH and RM Districts

Total square footage of all signs shall not exceed one (1) square foot per foot of road frontage. No individual sign face shall exceed sixty-four (64) square feet. No more than two (2) large sign faces shall be placed within 1,320 feet of each other on a single parcel. A large sign face is larger than thirty-two (32) square feet.

517.4.2 R-1 and E Districts

Total square footage of all signs shall not exceed one fourth (1/4) square foot per foot of road frontage. No individual sign face shall exceed eight (8) square feet. No more than two (2) large sign faces shall be placed within 1,320 feet of each other on a single parcel. A large sign face is larger than three (3) square feet. Illuminated or electronic signs are prohibited.

517.4.3 IG District

Total square footage of all signs shall not exceed two (2) square feet per foot of road frontage. No individual sign face shall exceed one hundred (100) square feet. No more than two (2) large sign faces shall be placed within 1,320 feet of each other on a single parcel. A large sign face is larger than thirty-two (32) square feet.

517.4.4 B-1, B-2 and B-3 Districts

Total square footage of all signs shall not exceed two (2) square feet per foot of road frontage. No individual sign face shall exceed one hundred twenty (120) square feet.

517.4.5 M-1, M-2 and M-3 Districts

Total square footage of all signs shall not exceed two (2) square feet per foot of road frontage. No individual sign face shall exceed one hundred twenty (120) square feet.

Allowable Signage by District

District	Total Signage (per foot of road frontage)	Largest Allowable Sign Face*	“Large” Sign Face Definition	Spacing between “Large” Sign Faces*
A, R-MH, RM	One (1) sq. ft.	64 sq. ft.	Greater than 32 sq. ft.	No more than two (2) large faces within 1,320 ft.
R-1, E	One-quarter (1/4) sq. ft.	8 sq. ft.	Greater than three (3) sq. ft.	No more than two (2) large faces within 1,320 ft.
IG	Two (2) sq. ft.	100 sq. ft.	Greater than 32 sq. ft.	No more than two (2) large faces within 1,320 ft.
B-1, B-2, B-3, M-1, M-2, M-3	Two (2) sq. ft.	120 sq. ft.	N/A	No Limit

*From Section 201: Sign (Face): The area of a sign containing a single message. For signs with a supporting structure, the area shall be defined by a rectangular area outlining the text or image.

Allowable Signage Examples

Standard R-1 or E District lot (150 ft of frontage, less than five (5) acre lot)	
	1 – 2 ft x 4 ft double-sided* sign (2 faces at 8 sq. ft. per face), plus 3 – 18 in x 24 in double-sided* signs (6 faces total at 3 sq. ft. per face), plus 1 – 12 in x 21 in double-sided* sign (2 faces at 1.75 sq. ft. per face)
OR	12 – 18 in x 24 in sign faces (3 sq. ft. per face), plus 1 – 12 in x 18 in sign face (1.5 sq. ft.)
Small R-1 District lot (100 ft of frontage, like Amlin Heights)	
	2 – 2 ft x 4 ft sign faces (8 sq. ft. per face), plus 3 – 18 in x 24 in sign faces (3 sq. ft. per face)
OR	8 – 18 in x 24 in sign faces (3 sq. ft. per face), plus 1 – 1 ft x 1 ft sign face (1 sq. ft.)
Very Small R-1 District lot (64 ft of frontage, like Murray Hill)	
	1 – 2 ft x 4 ft double-sided* sign (2 faces at 8 sq. ft. per face)
OR	2 – 18 in x 24 in double-sided* signs (4 faces total at 3 sq. ft. per face), plus 1 – 1 ft x 2 ft double-sided* sign (2 faces at 2 sq. ft. per face)
Typical A District housing lot (300 ft of frontage, five (5) acre lot)	
	2 – 8 ft x 8 ft sign faces (64 sq. ft. per face), plus 4 – 4 ft x 8 ft sign faces (32 sq. ft. per face), plus 2 – 4 ft x 5.5 ft sign faces (22 sq. ft. per face)
OR	5 – 3 ft x 10 ft double-sided* signs (10 faces total at 30 sq. ft. per face)
IG District lot with 300 ft of frontage	
	2 – 10 ft x 10 ft sign faces (100 sq. ft. per face), plus 12 – 4 ft x 8 ft sign faces (32 sq. ft. per face), plus 1 – 4 ft x 4 ft sign face (16 sq. ft.)
OR	20 – 3 ft x 10 ft sign faces (30 sq. ft. per face)
B or M District lot with 375 ft of frontage (like corner lot at Brush Row Rd and US 42)	
	4 – 10 ft x 12 ft sign faces (120 sq. ft. per face), plus 4 – 6 ft x 6 ft sign faces (36 sq. ft. per face), plus 2 – 2 ft x 15.5 ft sign faces (31 sq. ft. per face), plus 4 – 4 ft x 4 ft sign face (16 sq. ft. per face)
OR	2 – 10 ft x 12 ft sign faces (120 sq. ft. per face), plus 6 – 8 ft x 8 ft sign faces (64 sq. ft. per face), plus 6 – 4 ft x 4 ft sign faces (16 sq. ft. per face), plus 1 – 5 x 6 ft sign face (30 sq. ft.)
OR	6 – 10 ft x 12 ft sign faces (120 sq. ft. per face), plus 1 – 5 ft x 6 ft sign face (30 sq. ft.)

*In these examples, a double-sided sign is assumed to have a message on each side, therefore each side would count as a sign face.

SECTION 518 TOWERS

518.1 Towers may exceed the allowable height of buildings in all districts provided:

- 1 In Residential Districts the maximum height of all architectural features above grade shall not exceed twice the maximum permitted building height in the district and the required front, side, and rear yards shall each be increased by one (1) foot for each foot of additional feature height above the height regulations for the district in which the building is located.
2. In non-residential Districts the maximum height of all architectural features above grade shall not exceed 90 feet and the required front, side, and rear yards shall each be increased by one (1) foot for each foot of additional feature height above the height regulations for the district in which the building is located.
3. ORC 5502.031 and 519.211 limit the application of this section concerning wireless communication towers and amateur radio towers.

518.2. Fencing. Towers must have a fence completely surrounding the tower not less than five feet (5') in height with a locking gate.

518.3 Towers shall meet the minimum yard requirements specified for the District, However, extension of guy wires into a required side and rear yard is permitted.

SECTION 519 NON-CONFORMITIES

Within the districts established by the Resolution or amendments that may later be adopted there exist lots, structures, and uses of land structures which were lawful before this Resolution was passed or amended, but which would be prohibited, regulated, or restricted under the terms of this Resolution to permit these non-conformities to continue until they are removed, but not to encourage their continuance. Such uses are declared by this Resolution to be incompatible with permitted uses in the districts involved.

It is further the intent of this Resolution that non-conformities shall not be enlarged upon, expanded or extended, nor be used as grounds for adding other structures or uses prohibited elsewhere in the same district except by appeal to the Board of Zoning Appeals for approval of specific plans. Expansions of existing non-conforming uses, where allowed by the Board of Zoning Appeals, may be made only on property owned by the applicant as of the effective date of this Resolution.

A non-conforming use of a structure, a non-conforming use of land, or a non-conforming use of a structure and land shall not be extended or enlarged after passage of this Resolution by attachment on a building or premises of additional signs intended to be seen from off the premises, or by the addition of other uses of a nature which would be prohibited generally in the district involved.

To avoid undue hardship, nothing in this Resolution shall be deemed to require a change in the plans, construction or designated use of any building on which actual construction was lawfully begun prior to the effective date or adoption or amendment of this Resolution and upon which actual building construction has been diligently carried on. Actual construction is hereby defined to include the placing of construction materials in permanent manner; except that where demolition or removal of an existing building has been substantially begun preparatory to rebuilding, such demolition or removal shall be deemed to be actual construction, provided that work shall be diligently carried on until completion of the building involved.

519.1 Non-Conforming Lots of Record

In any district in which single-family dwellings are permitted, notwithstanding other limitations imposed by other provisions of this Resolution, a single-family dwelling and customary accessory building may be erected on any single lot of record at the effective date of adoption or amendment of this Resolution.

519.2 Non-conforming Uses of Land

Where, at the effective date of adoption or amendment of this Resolution, lawful use of land exists that is made no longer permissible under the terms of this Resolution as enacted or amended, such use may be continued, so long as it remains otherwise lawful, subject to the following provisions:

1. No such non-conforming use shall be enlarged or increased, nor extended to occupy a greater area of land than was occupied at the effective date of adoption or amendment of this Resolution except as provided.
2. No such non-conforming use shall be moved in whole or in part to any other portion of the lot or parcel occupied by such use at the effective date of adoption or amendment of this Resolution.

3. If any such non-conforming use of land ceases for any reason for a period of more than two years subsequent use of such land shall conform to the regulations specified by this Resolution for the district in which such land is located.
4. Where a non-conforming use of land by the nature of the use requires expansion or enlargement of the land area so used in order to continue in operation such as removal of sand, earth, stone, minerals, etc., continuance of such operations following the adoption or amendment of this Resolution shall be deemed a violation.

519.3 Non-Conforming Structures

Where a lawful structure exists at the effective date of adoption or amendment of this Resolution that could not be built under the terms of this Resolution by reasons of restrictions on area, lot coverage, height, yards, or other characteristics of the structure of its location on the lot, such structure may be continued so long as it remains otherwise lawful.

519.4 Non-Conforming Uses of Structures

If a lawful use of a structure or of structure and premises in combination exists at the effective date of adoption or amendment of this Resolution, the lawful use may be continued so long as it remains otherwise lawful, subject to the following provisions:

1. If no structural alterations are made, any non-conforming use of a structure, or structure and premises, may be changed to another non-conforming use provided that the Board of Appeals, either by general rule or by making findings in the specific case, shall find that the proposed use is equally appropriate or more appropriate to the district than the existing non-conforming use. In permitting such change, the Board of Appeals, in conjunction with the Zoning Commission may require appropriate conditions and safeguards in accord with the provisions of this Resolution.
2. Any structure, or structure and land in combination, in or on which a non-conforming use is superseded by a permitted use, shall thereafter conform to the regulations for the district in which such structure is located, and the non-conforming use may not thereafter be resumed.
3. When a non-conforming use of a structure, or structure and premises in combination, is discontinued or abandoned for twelve (12) consecutive months or for eighteen months during any two-year period, the structure, or structure and premises in combination shall not thereafter be used except in conformance with the regulations of the district in which it is located.

519.5 Repairs and Maintenance

On any building devoted in whole or in part to any non-conforming use, work may be done on ordinary repairs or replacement of non-bearing walls, fixtures, wiring or plumbing.

519.6 Restoring Buildings

When a building or structure, the use of which does not conform to the provisions of this Resolution, has been damaged by explosion, fire, act of God, or the public enemy, to the extent of twice its assessed value for tax purposes, it shall not be restored or reconstructed or in any way used except in conformity with the district regulations of the district in which the building is situated. When a non-conforming use qualifies for such reconstruction, a building permit shall be secured for that purpose within one (1) year from the date of occurrence of such damage and such reconstruction shall be diligently prosecuted and completed without delay. Failure to comply as above set forth shall cause such non-conforming uses to lapse and the premises shall conform thereafter to the established district regulations therein.

519.7 Violations not Rendered Non-Conforming

A use, structure, or lot which was in violation of the provisions of the Resolution which this Resolution amends shall not be validated or become non-conforming upon the adoption of this Resolution.

SECTION 520 TRAILERS

520.1 Temporary Residence

No person shall occupy any trailer as a permanent residence in any district. However, a temporary permit may be granted for up to one (1) year for use of a trailer or mobile home as long as it meets the County Health requirement while the owner is in the process of building a permanent residence on the same tract of ground or lot of record as long as it is not offensive to the surrounding area.

520.2 Camping and Sport Vehicles

All camping and sporting vehicles, including boats, must be parked at the side or rear of one's home when put up for storage. Storage shall be construed to mean, any vehicle parked for a ten (10) day period or longer.

SECTION 521 DRIVE-IN SERVICE ESTABLISHMENT

Establishments that by their nature create periodic lining up of customers in automobiles waiting to be serviced shall provide off-street waiting areas for these customers.

This includes such activities as:

Drive-in banks;

Quick auto wash;

Drive-in retail stores;

Drive-in service and repair drop stations for such items as clothing, appliances, equipment, etc.

Those establishments that can normally serve their customers in three minutes or less shall provide at least five (5) off-street waiting spaces per window.

Quick auto washes shall provide at least ten (10) off-street waiting spaces.

SECTION 522 BARRIERS TO ENCROACHMENT

Hereafter any lot used for parking, storage, or display of vehicles for sale or rent including boats, trailers, and trucks where such use is permitted to come within three (3) feet of any property line separating said lot from any property held by any other ownership including public land, such property lines shall be protected from encroachment by the installation of wheel stops, bumper guards or fencing so placed and erected as to prevent vehicles from projecting over said lines except at approved points of ingress and egress.

SECTION 523 ENFORCEMENT AND PENALTIES

523.1 Enforcing Officer

The Township Zoning Inspector is hereby designated as the enforcing officer of this Resolution. The enforcing officer is hereby authorized to enforce, issue orders to prevent and stop violations and administer the provisions of this Resolution; he/she may be assisted by such personnel as the Township Trustees may authorize. In order to effectively enforce the provisions of this article, the Board of Trustees reserve the right to employ and/or consult with additional persons or agencies deemed necessary.

523.2 Zoning Permit

No building or other structure shall be erected, moved, added to, or structurally altered without a zoning permit issued by the enforcing officer. Buildings and structures incidental to agricultural purposes are excluded (ORC 519.21). No zoning permit shall be issued except in conformity with the provision of this Resolution.

523.3 Certificate of Health Officer

In every instance where a lot is not serviced with public water and/or the disposal of sanitary wastes by means of public sewers, the application for a permit shall be accompanied by a Certificate of Approval by the County Health Officer of the proposed method of water supply and/or disposal of sanitary wastes.

523.4 Certificate of Zoning Compliance

It shall be a violation of this Resolution to use or occupy or permit the use or occupancy of any building or premises, or both, or part thereof hereafter created, erected, changed, converted, or wholly or partly altered or enlarged in its use or structure until a certificate of zoning compliance shall have been issued by the enforcing officer stating that the proposed use of the building or land conforms to the requirements of this Resolution. This provision shall apply to all buildings and uses, except buildings and structures incidental to agricultural purposes (ORC 519.21).

523.5 Remedies

If any building or land is used, altered, constructed, enlarged or any such action proposed in violation of the provisions of this Resolution or any amendment or supplement thereto, the Township attorney, the enforcing officer, or any person or property owner damaged by or subject to damage by such violation in addition to remedies provided by law is hereby empowered or authorized to institute appropriate action or proceedings to prevent such unlawful location, erection, construction, reconstruction, alterations, enlargement, change maintenance, or use.

523.6 Other Action

Nothing herein contained shall prevent the Township from taking such other lawful action as is necessary to prevent or remedy any violation, including issuing a uniform Misdemeanor Citation, for a continuing zoning violation.

523.7 Penalties

Violation of any provision of this Resolution or any amendment or supplement thereto, or failure to comply with any of the requirements of this Resolution shall constitute a misdemeanor. Any person, firm, or corporation violating any of the provisions of this Resolution, or any amendment thereto, or failing to comply with any of the requirements of this Resolution, or any amendment or supplement thereto, shall upon conviction be fined as determined by the Court, pursuant to Ohio Revised Code §519.99. In addition shall pay all costs and expenses involved in the case. Each day's continuation of a violation of this section may be deemed a separate offense.

523.8 Affected Parties

The owner or tenant of any building, structure, premises, or part thereof, and any architect, engineer, surveyor, building, contractor, agent, or other person who commits, participates in, assists in, or maintains a violation may be found guilty of a separate offense and suffer the penalties herein provided.

523.9 Driveways

Any and all access points on roads shall require a driveway permit and be constructed to the specifications listed on the permit.

523.10 Driveway Standard Regulations

The intent and purpose of driveway regulations are to provide a suitable means of ingress and egress between the road and the principal structures by the owners, occupants, delivery, and emergency vehicles. The improvements are to be installed and maintained by the owner. A driveway and culvert permit issued by the Xenia Township Road Department shall be required for any driveway cuts and before issuance of a zoning permit for any principal structure as defined in Section 201 of the Xenia Township Zoning Resolution. There shall be

no more than one principal structure per driveway, unless approved by the Xenia Township Board of Zoning Appeals. If approved, the Board of Appeals shall require all deeds include covenants and agreements indicating that the said lane or drive is a private drive and that it shall be maintained and kept in a state of good repair by the private landowners to whom the lane provides ingress and egress. The covenants and agreements shall clearly indicate that said private drive and individual turn-around are not public roadway and that Xenia Township shall have no responsibility for maintenance of the private drive and/or turn-around.

1. All driveways shall be constructed and subsequently maintained to meet the following standards.
 - a. A driveway must commence at a dedicated road.
 - b. Shall be a minimum width of 12 feet constructed with a base substantial enough to support vehicles to 40,000 lbs. gross vehicle weight (GVW);
 - c. Free from overhead obstructions to a height of 13 feet 6 inches and side-to-side obstructions to a width of 7 feet from the center line of the driveway;
 - d. Any incline, decline, dip, hump and/or curve must take into consideration the turning radius, ground clearance, and traveling envelope of all vehicles to include emergency vehicles.
2. Any driveway in excess of 1000 feet in length shall, in addition to the conditions/standards outlined in Section A, be required to also meet the following conditions:
 - a. Have a vehicle pull-off near the mid-point, and additional pull-offs for every 500 feet thereafter;
 - b. Have a turnaround at the end suitable for use by emergency vehicles;
3. Should Greene County Soil & Water recommend a culvert, pipe or bridge; no zoning permit will be issued until recommendations are completed. It is recommended that a pre-manufactured culvert, pipe or bridge be used. If a custom design is used, then it must be designed by a professional engineer and approved by the Township before construction.

SECTION 524 PRIVATE POOLS

A private swimming pool in excess of twelve (12) feet in diameter or with an area of greater than one hundred (100) square feet, excluding portable pools, shall be allowed in any district as an accessory use and shall comply with the following conditions and requirements:

1. The pool is to be used solely for the enjoyment of the occupants of the property on which it is located.
2. The pool shall be located a minimum of twenty (20) feet from any property line of the property on which it is located and must be placed to the rear of the main dwelling.
3. Above ground pools must have:
 - a. a fence completely surrounding the pool and deck area not less than five feet in height with lock, or
 - b. a top rail of at least five (5) feet above ground with steps that are removable or have a locking mechanism to prevent access from the outside, or
 - c. an approved (ASTM F1346-91) pool safety cover.
4. In ground pools must have:
 - a. a fence not less than five feet in height with locking gate, or
 - b. an approved (ASTM F1346-91) pool safety cover.

SECTION 525 VEGETATION CONTROL

Vegetation on any parcel in all zoning districts, excluding Agriculture and heavily wooded sections on parcels, shall be maintained so that it does not exceed 12" in height, excluding trees, ornamental shrubs, garden plants, etc.

SECTION 526 HOME OCCUPATIONS

Home occupations shall be permitted in the Agriculture District and Residential Districts (R-1 and E) in accordance with the following provisions:

No person or persons shall operate a home occupation or be employed thereunder other than a resident of the premises; except in the Agriculture District, there may be one employee other than a resident of the premises.

All home occupations shall be conducted entirely within the dwelling unit, and the use of the dwelling unit for the home occupation shall be clearly incidental and subordinate to its use as a residence. However, home occupations shall be permitted in any accessory building in the Agricultural District only.

Not more than twenty-five percent (25%) of the gross floor area of any dwelling unit shall be used for a home occupation.

There shall be no change in the outside appearance of the building or premises, or other visible evidence of the conduct of such home occupation other than allowable signage as defined in Section 517. There shall be no display of products visible from the street or surrounding properties.

Any need for parking generated by the conduct of such home occupation shall meet the off-street parking requirements as specified in Section 514 of this Resolution. A maximum of three parking spaces shall be designated for business use. No parking shall be located in a required front yard.

No equipment or processes shall be used which creates noise, vibrations, glare, fumes, odors or electrical interferences detectable outside the dwelling unit.

SECTION 527 ADULT BUSINESSES

Any proposed adult oriented business or adult entertainment facility must conform to the following standards. No advertisements, displays or other promotional materials shall be shown or exhibited so as to be visible from the exterior. All building openings, entries, windows, movie or video screens, loudspeakers or sound equipment for adult uses shall be located, covered, serviced or screened in such a manner as to prevent being seen or heard from the exterior. Signs are permitted as outlined in Section 517. No sign may contain any message or image that identifies specified sexual activities or specified anatomical areas.

Measurement of Distance Between Uses:

- (i) The measure of distance for purposes of this subsection shall be from property line to property line along the shortest possible course, regardless of any customary or common route or path of travel. The Zoning Inspector shall consider only: (1) whether the adult-oriented business or adult entertainment facility is seeking to locate in a M-3 District; and (2) whether the proposed location of the adult-oriented business or adult entertainment facility meets the minimum distance (in feet) from the uses listed in this Section. This determination shall be made without a public hearing being held and must be made within 10 business days of the receipt of a completed application for a zoning permit.
 - (ii) An applicant or an aggrieved party may appeal a decision of the Zoning Inspector to the Board of Appeals pursuant to Article VI of this Resolution. Such appeal must be made within 20 days of the claimed adverse decision.
1. **ADULT-ORIENTED BUSINESS** – includes an adult arcade, adult bookstore, adult novelty store, adult video store or similar business. Adult Oriented Businesses are subject to licensing approval by the Xenia Township Board of Trustees.

Minimum Setback shall be 500 feet from:

- a. residential district or dwelling
 - b. any school, library or teaching facility, whether public or private, governmental or commercial, which is attended by persons under eighteen (18) years of age.
 - c. any park or recreational facility attended by persons under eighteen (18) years of age.
 - d. any church, synagogue or permanently established place of religious services which is attended by persons under eighteen (18) years of age.
 - e. any other adult oriented business or any adult entertainment facility.
2. **ADULT ENTERTAINMENT FACILITY** – includes a business or commercial establishment that, as one of its principal business purposes, offers for any form of consideration, a place where two or more persons may congregate, associate or consort for the purpose of specified sexual activities or when one or more of the persons is semi-nude. Adult Entertainment Facility shall not include an establishment where a medical practitioner, psychologist, psychiatrist or similar professional person licensed by the State engages in medically approved or recognized sexual therapy. Adult Entertainment Facility includes an adult cabaret, adult motel, adult theater or adult entertainment in the form of semi-nude dancing or exhibition, semi-nude model studio, or sexual encounter establishment. Adult Entertainment Facilities are subject to licensing approval by the Xenia Township Board of Trustees.

Minimum Setback shall be 1000 feet from:

- a. residential district or dwelling
- b. any school, library or teaching facility, whether public or private, governmental or commercial, which is attended by persons under eighteen (18) years of age.
- c. any park or recreational facility attended by persons under eighteen (18) years of age.
- d. any church, synagogue or permanently established place of religious services which is attended by persons under eighteen (18) years of age.
- e. any other adult oriented business or any adult entertainment facility, or other establishment licensed by the State of Ohio for sale of beer or intoxicating liquor for consumption on the premises.

ARTICLE VI – BOARD OF APPEALS

SECTION 600 BOARD OF APPEALS

600.1 Creation

A Board of Appeals is created in accordance with Section 519.13 of the Ohio Revised Code. Pursuant to O.R.C. Sections 519.04 and 519.13, the trustees may appoint two alternate members to the Board of Zoning Appeals and Zoning Commission for terms to be determined by the Trustees. An alternate member shall take the place of an absent regular member at any meeting. An alternate member shall meet the same appointment criteria as a regular member. When attending a meeting on behalf of an absent member, that alternate member may vote on any matter on which the absent member is authorized to vote.

600.2 Membership and Appointment

The Board shall consist of five (5) members, appointed by the Township Trustees who may remove any member of the Board for cause upon written charges and after public hearing. Vacancies shall be filled by the appointing authority for the un-expired term of the member affected. Board members shall serve a five (5) year term and shall be eligible for reappointment. Members of the Board of Appeals existing at the time of adoption of this Resolution shall complete their appointed terms of office (ORC 3.07 and 102.01B).

600.3 Organization

The Board of Appeals shall elect its own officers annually and shall adopt the rules necessary to the conduct of its affairs. Meetings shall be held at the call of the chairman and at such other times as the Board may determine. Three (3) members of the Board of Appeals shall constitute a quorum for the conducting of business. The chairman, or in his absence, the acting chairman, may administer oaths and compel the attendance of witnesses. All meetings and records shall be open to the public.

600.4 Official Action

The Board of Appeals shall act by resolution or motion and shall keep minutes of its proceedings, showing the vote of each member upon each question, or of absence, or failing to vote. Any member who has a conflict of interest may abstain from voting, but must state his desire to do so prior to commencement of the hearing, and must also abstain from participation in the hearing. If a member participates in deliberations and then does not vote, the abstention will be counted as a vote to the majority. The Board must set forth facts upon which a decision is made, whether granting or denying a request, in compliance with requirements outlined in Section 600.8.4 for conditional uses and 600.8.5 for variances.

600.5 Right of Petition or Appeal

Any person, property owner, tenant, or any governmental officer, department, board of bureau may apply for a conditional use permit, or a variance from the strict applications of the terms of this Resolution or appeal a decision of the enforcing officer to the Board of Appeals.

An appeal of a ruling of the enforcing officer shall stay all proceedings unless the enforcing officer certifies that, by reason of facts pertaining to the matter in question, a stay in his opinion would cause imminent peril to life and property. When such certification is made, proceedings shall not be stayed except by a restraining order granted by the Board of Appeals or by the Court of Common Pleas.

600.6 Fee

When an application is filed, as provided in this section, and before any action shall be taken, any person desiring such action shall be required to pay a fee and under no condition shall

such sum or part thereof be refunded. Such fee schedule is determined by Xenia Township Trustee Resolution.

600.7 Hearing

The Board of Appeals shall fix a reasonable time for the hearing of any application, petition, or appeal. It shall give at least ten (10) days' notice of the time and place of such hearing to the enforcing officer and to the owners of record of property within five hundred (500) feet of the parcel in question. Such notice will be delivered personally or by mail or email addressed to the respective owners at the address given on the last assessment roll and by one (1) publication in one (1) or more newspapers of general circulation in the Township. For purposes of notification, parcels adjacent to, contiguous with, or directly across the street from the parcel in question and owned by the same owner shall be treated as one parcel. A sign no less than 9 sq. ft. per side and no greater than 32 sq. ft., provided by the Township, shall be set on the property no further than 10' from the right-of-way, clearly visible, near the access/driveway to the property. Any party may appear at such hearing in person, by agent or by attorney. The Board shall decide the application or appeal within a reasonable time.

600.8 Powers and Duties

The Board of Appeals shall have all the appropriate power and duties prescribed by law, and by this resolution. The Board shall have the following duties and powers:

1. **Administrative Review:**
To hear and decide appeals only in such cases where it is alleged there is error in any order, requirements, decision, or determination made by the enforcing officer in the enforcement of this Resolution. The concurring vote of three (3) members of the Board shall be necessary to reverse any order, requirement, decision, or determination of the enforcing officer, or to decide in favor of the applicant on any matter upon which they are required to pass under the terms of this Resolution. A public hearing shall be held as specified in Section 600.7 of this Resolution.
2. **Determination of Similar Uses:**
To determine if uses not specifically mentioned in this Resolution are similar to uses permitted within a district. A public hearing is not required for a Similar Use determination.
3. **Determination of District Boundary Location:**
To determine the exact location of any district boundary if there is uncertainty as to exact location thereof. In making such determination the Board shall be guided by the provisions of Section 302. A public hearing is not required for a District Boundary determination.
4. **Conditional Use Permits:**
To hear and decide only such conditional uses as the Board of Appeals is specifically authorized to pass under the terms of this Resolution, or to deny conditional use permits when not in harmony with the intent and purpose of this Resolution or the Comprehensive Master Plan. The following requirements shall be complied with prior to any approval or denial of a conditional use permit by the Board of Appeals:
 - a. A written application for a conditional use is submitted as indicated in the section of this Resolution under which the conditional use is sought and stating the grounds on which it is required.
 - b. A public hearing shall be held as specified in Section 600.7 of this Resolution.
 - c. The Board of Appeals shall determine:
 - (1) **Authority:** It has the authority to grant the request.

- (2) Adverse Effect: That the granting of the conditional use will not adversely affect the neighborhood in which the conditional use is to be located.
 - (3) Master Plan: That the conditional use is not one which is contrary to the Comprehensive Master Plan of Xenia Township, providing this Plan has been updated within five (5) years prior to the Board's determination of the conditional use in question. In making this determination, the Board may be advised by the recommendation of the Township Zoning Commission.
 - (4) Conditions: In granting any conditional use permit, the Board of Appeals may prescribe appropriate conditions and safeguards in conformity to the provisions of this Resolution and the recommendation of the Township Zoning Commission. A conditional use permit shall expire in one (1) year after it is issued unless actual construction has taken place or is underway except as provided elsewhere in this Resolution.
 - (a) A Conditional Use does not require undue hardship to be allowable.
 - (b) A Conditional Use shall be granted to the applicant/owner and such use shall not pass along to the succeeding property owner or occupant.
5. Variances: To vary the strict application of any of the requirements of this Resolution only in the case of exceptionally irregular, narrow, shallow or deep lots, or other exceptional conditions, whereby such strict application would result in practical difficulty or unnecessary hardship - not economic in nature - that would deprive the owner of the reasonable use of the land or building involved. The fact that another use would be more profitable is not a valid basis for legally granting a variance. No non-conforming use of neighboring land, structures, or buildings in the same district, and no permitted use of lands, structures, or buildings in other districts shall be considered grounds for the issuance of a variance. No variance in the strict application of this Resolution shall be granted by the Board of Appeals unless and until the applicant submits, and the Board concurs, with the following:
- a. Conditions and Circumstances: That special conditions and circumstances exist which are peculiar to the land, structure or building involved and which are not applicable to other lands, structures, or buildings in the same district.
 - b. Property Rights: That literal interpretation of the provisions of this Resolution would deprive the applicant of property rights commonly enjoyed by other properties in the same district under the terms of this Resolution.
 - c. No Special Privilege: That granting the variance requested will not confer on the applicant any special use privilege that is denied by this Resolution to other lands, structures, or building in the same district.
 - d. Harmony with Locality: That the variance requested shall not alter the essential character of the locality, nor be in conflict with the Comprehensive Master Plan. In making this determination, the Board of Appeals shall be advised by the recommendation of the Township Zoning Commission.
6. Procedure for Consideration of Petition for Variance:
- a. The Board of Appeals shall make a finding that the reasons set forth in the application are valid and justify the granting of the variance. The Board shall

also determine if the variance is the minimum variance that will make possible the reasonable use of land, building or structure.

- b. Under no circumstances shall the Board of Appeals grant a variance which will contradict zoning.
 - c. Public Hearing: Prior to taking action on a request for a variance the Board of Appeals shall hold a public hearing and give notice to property owners as in Section 600.07 of this Resolution.
7. **Effective Date:**
The decision of the Board of Appeals shall not become final until the expiration of five (5) days from the date of entry of such order unless the Board shall find the immediate effect of such order is necessary for the preservation of property or personal rights and shall so certify on the record.

ARTICLE VII - AMENDMENTS

SECTION 700 AMENDMENTS

The Township Trustees may from time to time amend, supplement, change or repeal this Resolution in the manner prescribed by Section 519.12 of the Ohio Revised Code and in accord with the following:

700.1 Right of Amendment

A proposed amendment may be initiated by the Township Zoning Commission, the Township Trustees or by the filing of an application with the Township Zoning Commission or by one or more of the owners or lessees of property within the area proposed to be changed. All such proposals originating with the Township Trustees shall be certified to the Township Zoning Commission.

The Township Zoning Commission shall set a public hearing date, not less than 20 days or more than 40 days, on the proposal and refer the matter to the Greene County Planning Commission within 5 days for a recommendation for approval or denial within 25 days after receipt of such application.

700.2 Recommendation of Township Zoning Commission

The Township Zoning Commission, within 30 days after public hearing, shall recommend the approval, denial or modification of the proposed amendment and submit such recommendation and the recommendation of the Greene County Planning Commission to the Township Trustees.

The Township Trustees shall, upon receipt of such recommendation, set a public hearing date on the proposed amendment, which date shall not be more than 30 days from the date of receipt of such recommendation. Within 20 days after such public hearing the Township Trustees shall either adopt or deny the proposed amendment or adopt some modification thereof. In the event the Township Trustees, after public hearing, deny or modify the recommendation of the Township Zoning Commission, the majority vote of the Township Trustees shall be required. Amendments adopted by the Trustees become effective 30 days after the adoption of the amendments.

700.3 Amendment Limitations

Petitions for zoning amendment, conditional use permits, or variances concerning any parcel of property, portion thereof, or use thereon shall not be accepted for consideration more than once during any consecutive twelve (12) month period.

700.4 Continuation of Public Hearings

Requests for continuance of a public hearing may be granted in thirty (30) day increments, but in no case will a continuance be granted which exceeds six (6) months from date of filing of application.

700.5 Fee

When any petition is filed as provided in this section, and before any action is taken, any person desiring such action shall be required to pay a fee and under no condition shall such sum or part thereof be refunded. Such fee schedule is determined by Xenia Township Trustee Resolution.

700.6 Validity and Severity

Should any section or provision of this resolution be declared by the courts to be unconstitutional or invalid, such decision shall not affect the validity of the Resolution as a whole, or any part thereof other than the part so declared to be unconstitutional or invalid.

700.7 Interpretation and Conflict

In its interpretation and application, the provisions of this Resolution shall be held to be minimum requirements, adopted for the promotion of the public health, morals, safety and

general welfare. Wherever the requirements of this Resolution are at variance with the requirements of any other lawfully adopted rules, regulations, or Resolutions, the most restrictive, or that imposing the higher standards, shall govern.

700.8 Repeal of Conflicting Resolution

All Resolutions, or parts of Resolutions in conflict with this Resolution or inconsistent with the provisions of this Resolution, are hereby repealed and declared null and void and of no effect.